

ANNUNCIATOR

NOVEMBER 1997

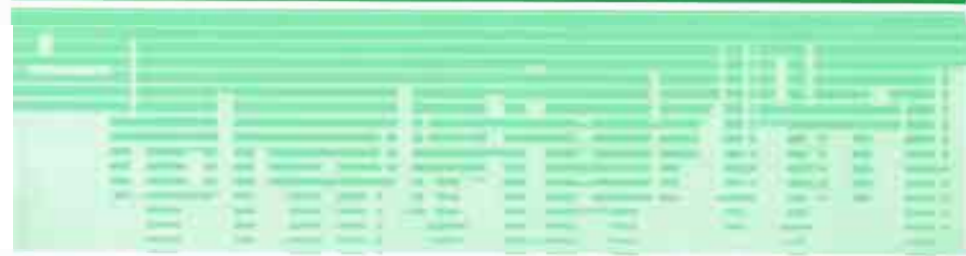

SARNIA



SECTION

The International Society
for Measurement and Control





GREAT LAKES (Division of MENTEC) INDUSTRIAL CONTROLS®

Phone: (519) 336-9512

Fax: (519) 336-9834



BROOKS ... LOOP-POWERED Oval-Gear Flow Meters For High Viscosity Low Pressure Drop Applications, Rotameters, Purge-Meters, Massflow Meters & Controllers For Liquids & Gases



DEKORON
FURON - UNITHERM

..... Preinsulated and Pretraced Tube Bundle Products, Heated Hose, Ultra High Integrity Instrument Signal Cable That Can Survive For 1 Hour Under Full-Blown Fire Conditions, Electrical Heat Tracing Systems and Controls



..... Severe Service Control Valves With Class 8 Shut-Off, Optical Laser-Beam Valve Positioning Systems, Controllers, Instantaneous Steam-Water Heaters, Steam-Water Mixers, Non-Fouling Gas & Steam Regulators, K-MAX Rotary Control Valves, Emergency Process Shut-Off Valves



**RUFFNECK
Heaters**

... Steam & Glycol Unit Heaters, Ex-Proof Electric Unit Heaters, Ex-Proof Thermostats



**TEXAS
SAMPLING**

..... Custom Closed-Loop Sampling Systems For Liquids & Gases, Emission-Free Design With Zero Dead-Volume Sampling, Manual & Automatic Operation

Treerice

..... Pressure-Gauges & Diaphragm Seals, Thermometers, Fail-Safe Temperature Regulators, Automatic Steam Tracing Control Valves To Prevent Instrument Enclosures From Overheating



**WATTS
INDUSTRIES**

..... High-Performance Ball & Butterfly Valves, API & EXXON Firesafe Approved, Pneumatic & Electric Actuators, Anti-Fugitive Emission Valves

YARWAY

..... Steam Traps & Strainers & Expansion Joints

1387 Confederation St., Sarnia, Ontario N7S 5P1

List of Advertisers

Company	Page No.	Company	Page No.
ABB-Kent Taylor	37	Line Process Controls	50
Alpha Controls	39	Lisle-Matrix	4
Armatek Controls	30	Mac-Weld	60
Associated Valve Corp.	9	Matheson Valve	64
BSP Instruments	17	Milltronics	16
Bestobell Canada	62	Moore Products Co. (Canada) Inc.	23
Brian Controls	6	Novatech	10
Cambridge Controls	27	Omnitronix	25
Campbell Scientific	20	Ovantum	25
Cancoppas Ltd.	48	Phoenix Contact Ltd.	36
Cantech Controls	35	Professional Valve	20
Cantrols	42	Prosigma Analytics Inc.	21
CTH Industrial Controls	26	Provincial Controls	59
CB Engineering	24	R.A. Kirby Sales Inc.	55
CEM Specialties Inc.	15	Regional Process Equipment	8
Contro Valve Inc.	33	Romatec	18
Davis Controls	35	Rosemount	54
Durham Instruments	55	Samson Controls Inc.	79
Dräger	21	Sarnia Piping Specialties	32
Elsag Bailey Inc.	12	Semac Power & Controls	7
Endress & Hauser	8	Sharp Valve	7
Farris Industries	57	Southwest Meters	4
Fisher Service	62	Spec (Sarnia) Ltd.	44
Floval Equipment	39	Spirax Sarco	15
Fryston Canada	45	Summit Controls Ltd.	58
Great Lakes Industrial Controls	2	Syber Systems	44
HCS Heating & Control Systems	51	Technorth Canada	35
Hardie Industrial Supplies	16	Transcat	19
Honeywell Ltd.	63	Trillium Measurement & Control	22
Huron Valve	22, 78	Tubetech Ltd.	12
ICS - Triplex	50	United Electric	19
IMO Industries	38	Utility & Industrial Supply	13
Industrial Projects Ltd.	38	Veronics Instrument	4
Intertec Instrumentation	7	Wesco Industrial Control Products .	40,41
ISA Distribution Centre	60	Westburne Lytle	13
J&M Engineering	5	Westech Industrial	56, 61
Lakeside Process Controls	80	Wika Instruments	22
Langtree Controls Ltd.	17	Willer Engineering	48

INSTRUMENTS VERONICS Inc.

220 Wyecroft Road, Unit 15, Oakville, ON L6K 3T7

Tel: (905) 842 5664, Fax: 842-0540

Email: sjl@globalserve.on.ca



PANAMETRICS

Moisture Analysers

- Levels from 1 ppb
- fast response
- Portable/On-line

Flow Meters

- Ultrasonic
- Liquid and Gas
- Flare Gas Meters

Gas Analysers

- Flue Gas
- Oxygen
- Hydrogen



IONICS

IONICS, INCORPORATED

Analysers for TOC/TOD,
Metals,
Process Titrators
Chemical Analysis.

DGS

DOVER GAS TECHNOLOGIES

Analysers for:
CO₂, CO, Oxygen,
SO₂, NOX, Hydrogen.
Portable and On-line.

SeaMetrics

Meters and Control for Flow Monitoring

Turbine Meters
Paddlewheels
Contact Head Meters



Olin Instruments
OLIN CORPORATION

Moisture Analysers for:
Corrosives, Liquids &
Gases.
On-Line GC analysis
using PID Detector.

LISLE-METRIX LTD.

49 Sheffield Street, Toronto Ontario M6M 3E5
Telephone: (416) 249-9151 Fax: (416) 249-2952

WATER QUALITY ANALYZERS - pH, ORP, Conductivity,
Dissolved Oxygen, Turbidity

FLOW METERS - Area, Doppler, Flume, Impeller, Mass,
Nozzle, Thermal, Turbine, Venturi

PROCESS PHOTOMETERS - Dust, Oil-In-Water,
Ozone, Turbidity, Colour, Nitrate, Dissolved Organics,
Solvents in Effluent, Water in Organic Solvents

LEVEL SENSORS - Conductance, Magnetic Coupled

I.S. BARRIERS, ISOLATORS, LOGIC CONTROLS

PROXIMITY SWITCHES - Capacitive, Inductive, Optical,
Ultrasonic, Magnetic, Photoelectric, Fibre Optic

PANEL INDICATORS & CONTROLLERS

SOUTH-WEST METERS LIMITED

P.O. BOX 1083
765 EVETT STREET
SARNIA, ONTARIO N7S 5N3
BUS: (519) 336-8628
FAX: (519) 336-9082

"WE MEASURE UP TO YOUR STANDARDS"

Shop and Field Services Provided:

- Certified Meter Proving & Repair
- Instrument Repair
- Liquid Transfer Systems
- Weight & Measures Calibration
- Preventative Maintenance Programs
- Tank Level Equipment

Contents

President's Corner	11
Sarnia Section Executive	14
ISA Mission Statement	15
ISA Member Benefits	26
Lambton College Instrumentation & Technology	28, 29
ISA - CCST Exam Schedule	31
Past President's Honour Roll	34
ISA Membership Application Form	43
The PLC vs The PC	46, 47
Upcoming Dinner Meetings	49
Internet Rates	52
News Release	53, 57
Winners & Whiners	65
User's Directory	66

Editor's Notes

ADVERTISERS: Please note that the deadline for the JANUARY ANNUNCIATOR is December 15, 1997. Please forward information to the editor by that date in order to have items updated.

THE DINNER MEETINGS FOR THE 1997/98 SEASON WILL BE HELD AT THE SARNIA GOLF AND CURLING CLUB

ISA Sarnia Section
Box 206, Sarnia ON N7T 7H9

ISA Sarnia Section BBS
(519) 541-0427

Upcoming Executive Meetings

February 23, 1998 • April 27, 1998 • June 29, 1998

All regular meetings will be held at 7:00 p.m. at the Sarnia Golf & Curling Club



J & M ENGINEERING & SALES LTD.

2899 STEELES AVE., W., UNIT 4, DOWNSVIEW, ONTARIO, CANADA M3J 3A1
TEL: (416) 665-2300 FAX: (416) 665-7530

Representing the Experts in Measurement and Control

Badger Meter Inc.

Liquid Meters and Batching Control Systems, Ultrasonic Flowmeters, Open Channel and Closed Pipe, Flow Tubes & Ultrasonic Level.

Wallace & Tiernan Inc.

Flowmeters, Chlorinators, Line Slakers, Metering Pumps, Feeders & Calibrators.

Lumenite Electronic Company

Conductivity & RF Capacitance Level Products.

Wilkerson Instrument Co., Inc.

Signal Conditioners, 2 Wire Transmitters, Indicators & Alarms.

Flowdata Inc.

Positive Displacement Flowmeters & Flow Controls for Special Applications.

L.J. Star Inc.

Visual Flow & Sight Glass Indicators

Danaher Controls

Digital Meters, Counter, Timers & Encoders.

"Where You Get Old Fashioned Service"

BRIAN CONTROLS

A DIVISION OF **PEACOCK**

A WEIR GROUP COMPANY

Process Control • Calibration and Test Equipment

Measuring Instrumentation (for flow, level, pressure, temperature, pH, ORP, conductivity)

Safety and Environmental (gas detection, gas analyzing, CEM and ambient air quality monitoring)

AMETEK

Pressure and temperature gauges, diaphragm seals, deadweight testers, pressure and temperature calibrators, transducers and transmitters



Portable and fixed gas detection



Manifold valves; gauge and needle valves

CONTROL MICROSYSTEMS

Remote monitoring and control, RTUs, telemetry and communication products, SCADA systems

DELTA

Flow switches; level switches



Rupture discs; explosion vents

GEORGE FISCHER +GF+ SIGNET

Actuated/pressure regulating valves; flow products



Flow metering systems

Honeywell

Pressure, level, flow, and temperature transmitters, controllers; recorders; digital control programmers; control valves



Variable area flowmeters; turbine meters



Gas mass flow measuring systems



Primary flow elements; differential pressure flowmeters

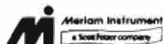

Manometers; flow elements; flow and pressure calibration

Mid-West

Differential pressure indicators and switches



Ambient air analyzers



Jet pumps; sight flow indicators; direct reading liquid level gauges; magnetic level gauges; Levelmark ultrasonic and capacitance level detectors; thermocouples and RTDs



Radar level / tank gauging



Magnetic flowmeters



Bimetal and gas actuated thermometers



Pressure and temperature controls

*Sales, service, and distribution across Canada since 1956
stocking warehouses • on-line computer system • order tracking
specialized shop services • calibration services traceable to N.I.S.T. • field start up services*

ONTARIO REGION

Sarnia tel.: (519) 337-7591 fax: (519) 336-0997

Mississauga tel.: (905) 813-8310 fax: (905) 813-0570

or toll free: 1-800-313-3103

**Solutions in
Measurement
& Control**

SHARP

VALVE & INSTRUMENTATION INC.

SARNIA – MISSISSAUGA

Official and Authorized Representatives for:
ROCHESTER INSTRUMENT SYSTEMS, LIMITORQUE, FIKE,
SHAND & JURIS, L&J TECHNOLOGIES, RESISTOFLEX,
WIKA, HEX VALVE, KOMAX HEATERS, DURABLA,
LUDLOW-RENSSEALER

PHONE: (519) 336-8484

FAX: (519) 336-0928

**1407 PLANK ROAD
SARNIA, ONTARIO**

COMPLETE PRESSURE RELIEF, BALL, GATE, GLOBE, PLUG,
BUTTERFLY, CONTROL VALVE AND ACTUATOR REPAIR.
FULL CALIBRATION SERVICE.

INTERTEC



FURON UNITHERM

**ENCLOSURES CABINETS HEATERS MANIFOLDS
PRE-INSULATED & TRACED BUNDLE**

INTERTEC INSTRUMENTATION LTD., 400 MOROBEL DRIVE, MILTON, ONTARIO, L9T 4N6
TELEPHONE (905) 875 4727 FAX (905) 875 4729
REPRESENTED BY ATS - HOLLAND INC. SARNIA

SEMAC Power & Controls Ltd.

525 Vidal Street S., Sarnia, Ontario • Tel (519) 336-5986 / Fax(519) 336-4490

Custom Electrical / Mechanical Panel Shop / C.S.A. / U.L. Certified / Installations / Service

Instrument & Electrical Field Contracting / Analyzer Shelters / Systems

PLC Controls / Scada / DCS Controls / 24hr Emergency Service Available / Contract Basis

Endress+Hauser

Measurement for Automation



FLOW

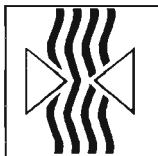

Electromagnetic Flowmeters, straight-tubed Coriolis Mass Flowmeter, Vortex Meter with E + H patented DSC sensor.

Level detection and measurement by:
Conductivity, Vibronics, Capacitance, Hydrostatic, Ultrasonic & Microwave - the *widest* choice by any manufacturer.

LEVEL

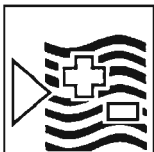
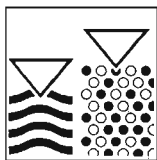

LIQUID ANALYSIS

pH/Redox
Conductivity
Turbidity
Dissolved Oxygen
Chlorine

LIQUID

Cerabar family of Smart Pressure Transmitters & Switches, Deltabar Smart Differential Pressure Transmitters with self-checking ceramic cell.

PRESSURE

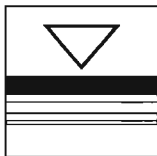

MOISTURE



Full range of Hygrometers and Relative Humidity Meters using polymer and smart aluminum oxide sensors for all your moisture measurement needs in both gases and liquids.

**For sales and support call
1-800-668-3199**

Endress + Hauser

1440 Graham's Lane, Unit 1
Burlington, Ontario L7S 1W3
Phone: (905) 681-9292
Fax: (905) 681-9444



REGIONAL PROCESS EQUIPMENT

Xomox Tuflin Sleeved & fully lined Plug Valve, Pliaxseal High Performance Butter fly, lined Port Valves, Matryx Actuators

KTM Ball Valves 2 ways reduced & Full Port, 3 ways Hi- Temp Granite Seats, Metal Seated, Exxon Approved.

Orbe Knife Gates Valves Ansi # 150 lug, or flanged Knife gates 2" to 72" Diameters, 316 S.S, 254 SMO, Titanium, Cast Iron

Valvtechnologies Inc. High Performance metal seated ball valve RC 73 Rockwell, Electronic Pressure Relief

Senior Flexonics Custom Metal Flex hoses, Chlorine & Chemical Transfer Flex hoses, Fabric & Metal Expansion Joints

INSTRUMENTION

Endress + Hauser Canada. Level Instruments, Pressure & Microwave. Flow Instruments, Pressure Instrumentation

Crowcon Gas Detection Multi point Fixed Systems. Personal & Portable Gas Detection

Wika Instruments Canada Pressure & Vacuum gauges, Trend Bimetal, Vapor & Gas Acturated Thermometers, Pressure Transmitters & Transducers, Diaphragm Seals & Filling, Thermowells & Protection Tubes

Fairchild Transducer & Regulators small Modular Transucers, Non position sensitive resistant to high vibration, CSA, Explosion Proof

**ASK ABOUT OUR COMPLETE VALVE
AUTOMATION SERVICE**

777 Campbell Street, Unit #2. Sarnia, Ontario
PH: (519) 337-7758 PH: (519) 337-7933

Regional Process Equipment

777 Campbell Street, Unit #2, Sarnia, Ontario, N7T 2J7
PH: (519) 337 7758 FAX: (519) 337 7933

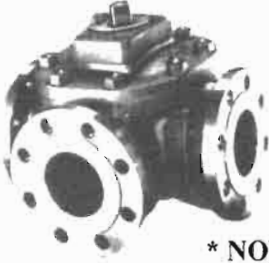

Ball Valves

- ISO 9000 certified
- Exxon approved
- Nace Trim
- API 607 certified
- Metal Seat-High Temp
- 3 way, 2 & 4 seat



*** NOW STOCKED IN SARNIA ***

Tong Yung Gates Globes & Check Valves

- ISO 9000 Certified
- Exxon & API 607 approved
- Nace Trim
- ANSI 150#, 300, & 600#



Full Automation & Control Services



Associated Valve

*** NOW AVAILABLE FULL AUTOMATION ***

Montreal









5600 Cypriot
 Ville St-Laurent (Quebec) H4S 1V7
 Tel.: (514) 339-5374 Fax: (514) 339-1550
 Technical Support 1-800-465-5374
 E-mail: novatech@netcom.ca

NOVATECH
 Instrumentation • Process • Environment



Toronto

160 Wilkinson Road, Unit 38
 Brampton (Ontario) L6T 4Z4
 Tel.: (905) 453-7224 Fax: (905) 453-2464
 Technical Support 1-800-465-5374
 E-mail: novatech@netcom.ca





GAS ANALYSIS

<p>1</p>  <p>Servomex LEADERS IN GAS ANALYSIS</p> <p>Paramagnetic and zirconia oxygen analyzers. Photometers for stack and process. Continuous Emission Monitoring Systems (CEMS).</p>	<p>8</p>  <p>Toxic and combustible gas detection. Ultrasonic flow and level monitoring. Water quality analysis.</p>
<p>2</p>  <p>Environmental Technologies Group, Inc.</p> <p>Open path FTIR systems. Detection of metals in water.</p>	<p>9</p>  <p>Molecular Analytics, LLC</p> <p>Ion-mobility spectrometers for emission, process and ambient monitoring.</p>
<p>3</p>  <p>BEI Baldwin Environment, Inc.</p> <p>Sample conditioning systems for: CEMS, both portable and fixed. Sample probes.</p>	<p>10</p>  <p>Trace level gas moisture analyzers. PPB, PPM detection levels. Portable and fixed analyzers.</p>
<p>4</p>  <p>GASCO GAS ANALYSIS SYSTEMS COMPANY, INC.</p> <p>Portable FID/GC In-door air quality.</p>	<p>11</p>  <p>Portable stack monitoring analyzers.</p>

LIQUID ANALYSIS

<p>5</p>  <p>TYTRONICS INCORPORATED</p> <p>On-Line process titrators, colorimeters, and photometers. TOC analyzers.</p>	<p>12</p>  <p>Industrial process pH, conductivity, ion-selective electrodes and transmitters.</p>
--	---

GENERAL PRODUCTS

<p>6</p>  <p>Chemical metering pumps, controllers, and accessories.</p>	<p>13</p>  <p>On-Line moisture measurement in solids. Utilizing radio-frequency principle.</p>
<p>7</p>  <p>NOVATECH Engineering Group</p> <p>Customized systems integrators. Application engineering, technical support. Sample multiplexing systems. Continuous Emission Monitoring Systems.</p>	<p>14</p>  <p>Signal conditioners, isolators, alarm modules, and multiplexers. Linearizers, integrators, and transmitters for frequency, temperature, and strain gauges.</p>



The International Society
for Measurement and Control

Incoming President's Message

Our year began on a positive note with a well attended dinner meeting at the Sarnia Golf and Curling Club. The guest speaker from Allen Bradley gave a very informative presentation on DeviceNet.

Jennifer Southcombe, ISA Sarnia Section Membership Chairperson, gave a presentation on the launch of our Membership drive which will recognize members for their efforts in promoting ISA and successful recruiting of new members. Please look for the details on this program included in the Annunciator and we look forward to your participation.

The Education Chairman, Kalpen Vachharajani, has reported that a training session on Control Programming Using IEC-1131 was held at the CAPT Center. Additional sessions are being planned and Kalpen would welcome any suggestions from the membership on topics.

The ISA Sarnia Section participated in the TECH 97 Show at Anaheim with both delegates and the Student Section. ISA sponsored the student team in the competitions at the ISA show and I am happy to report that they came in fourth overall. Congratulations to the team and their leader / Tour Guide Mike Grey for a job well done.

ISA recently has published a listing of the 100 Best Web Sites dedicated to control. I would like to recognize our WebMaster, Brian Smith, for having his site included. I would encourage you to visit at bsmith@ebtech.net.

I would hope to see our numbers for the attendees at the dinner meetings increase, so please let your friends and co-workers know about our meeting on November 24 to ensure its success.

Regards,

Andy Tucker, *President*

TubeTech LTD.

Instrumentation
and Fluid Control

829 Phillip Street
P.O. Box 968
Sarnia, ON N7T 7K3

Tel: (519) 344-5271
Fax: (519) 344-8334

BAILEY
FISCHER
PORTER **F**

OHMART VEGA

**ALLTEMP
SENSORS**

Hartman
& Braun

ASCO

Barksdale

Parker
Fluid Connectors

TBI-Bailey

EB
Elsag Bailey

Customer Service is our best product !



Elsag Bailey
Process Automation

Your Measurement of Quality.

BAILEY
FISCHER
PORTER **F**

Magnetic Flowmeters, Mass Flowmeters, Rotameters,
Level Indicators, Vortex Meters,
Swirlmeters, Transmitters, Controllers, Combustion and
Emissions Analyzers, and Opacity.

SENSYCON
Hartmann & Braun

Temperature Transmitters, Trend Recorders,
Smart Valve Positioners, Electric Actuators.

TBI-Bailey

Sensors, Indicator/Analyzers and Controllers:
For pH, ORP and Conductivity.

Elsag Bailey (Canada) Inc.
134 Norfinch Drive
Downsview, ON M3N 1X7
Tel: 800-663-7097/
416-667-9800 ❖
Fax: 416-667-9816

Products represented locally by:

TubeTech Ltd.
829 Phillip Street, P.O. Box 968
Sarnia, ON N7T 7K3
Tel: (519) 344-5271 ❖ Fax: (519) 344-8334



WESTBURNE LYTLE



INDUSTRIAL PRODUCTS DIVISION SARNIA

- A.S.I.** – Multipoint Level Indicators
- ASCO** – Solenoid Valves, Pressure and Temperature Switches
- CASH-ACME** – Reducing and Regulating Valves
- CLIF MOCK** – Liquid and Gas sampling systems, Liquid P.D. meters
- DOPAK** – Process Samplers
- EL-O-MATIC** – Actuators, Positioners, Switches, etc. for Quarter Turn Valves
- E.V.I.** – Engineered Ball Valves for Special Applications
- GGOSCO** – Needle Valves
- PROMAG** – Magnetic Liquid Level Indicators & Continuous Level Transmitters
- TRICENTRIC** – Metal Seated, Class VI, Butterfly Valves
- VELAN** – Ball Valves - Cryogenic, Metal Seated, Resilient Seated

1231 Confederation Street , Sarnia, N7S 4M7
Telephone: (519) 336-0014 Fax: (519) 336-7396

UTILITY & INDUSTRIAL SUPPLY LTD. U & I SUPPLY LTD.

P.O. Box 999, 645 Kedco St.
 Sarnia, Ontario N7T 7K6
 Phone: (519) 344-3614
 Fax: (519) 344-3181
TOLL FREE: 1-888-814-4673

- | | |
|--|--|
| <p>CHEMTROL - Kaynar, PVC, CPVC, Ball Valves, Check Valves, Butterfly & Actuators</p> <p>WORCESTER CONTROLS
- Ball Valves, Electric & Pneumatic Actuators</p> <p>KEDDCO MANUFACTURING
- Orifice Plates, Spectacle Blinds, Strainers, Bull Plugs</p> | <p>FLEXIBOX - Metastream & Powerstream Flexible Mechanical Couplings</p> <p>TVL - Steam Traps, Condensate Pumps, Separators</p> <p>HILTAP - Special High Temperature & Flow Couplings</p> <p>SEEPEX - Progressive Cavity Pumps, Metering Pumps</p> |
|--|--|

**ALL TYPES OF HOSES AND FITTINGS ASSEMBLED AND TESTED
 AN ISO 9002 CERTIFIED COMPANY**

Over 40 Years of Mechanical and Fluid Transfer Experience

Sarnia Section Executive 1997-98

Position	Incumbent	Phone	Fax
		(Area Code 519)	
President	Andy Tucker	383-3704	383-8285
Vice-President	TBA		
Past President	Randy Dennie	337-8252 ext. 5871	339-7723
Education Chairman	Kalpen Vachharajani	332-1717	332-1186
Treasurer	Jeff Talbot	344-5271	344-8334
Assistant Treasurer	Brian Patterson	337-7591	336-0997
Executive Assistant	TBA		
Newsletter Chairman	Bob Devine	332-2300	332-6640
Newsletter Editor	Brad Simpson	337-3200	337-7068
Newsletter Assistant	Rob Thrift	336-0201	336-0209
Web Master	Brian Smith	332-1212 ext. 7920	339-7305
Program Chairman	Ian Shouldice	1-800-265-0259	336-0997
Program Assistant	Glen Williamson	481-3202	
Honours & Awards Chairman	Aldo DeSantis	344-4300	344-0042
Honours & Awards Assistant	Guy Salt	344-4300	344-0042
Membership Chairman	Jennifer Southcombe	337-2301 ext. 480	383-1736
Membership Assistant	Mike Murray	383-1709	339-0481
Student Section Liaison	Mike Grey	542-7751 ext.308	542-6667
Standards and Practices	Don Murch	431-1916	431-1127
Standards and Practices Asst.	Umesh Patel	339-9701	339-9702

CEMs for COMPLIANCE or PROCESS CONTROL?

NO_x SO₂

CO₂ TRS Hg

THC O₂

HCl CO

NH₃

**CEM
Specialties Inc.**

tel: (519) 641-6431
fax: (519) 641-6536
admin@cemsi.on.ca
http://www.cemsi.on.ca

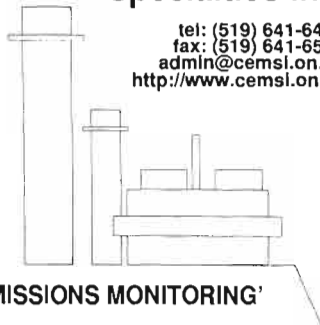

'SPECIALISTS IN
CONTINUOUS EMISSIONS MONITORING'

- Discrete Gas Analyzer Systems
- Bodenseewerk/Perkin Elmer Analyzer Systems
- Sampling Probes and Heated Umbilicals
- FID Analyzers (Portable / 19" Rackmount)
- M&C Products Gas Conditioning Systems
- Opacity and Dust Concentration Monitors
- QA/QC Plans

Working towards ISO 9001 Registration

**spirax
/ sarco**

If it is a Question of...

HEAT TRANSFER, FLUID CONDITIONING, MONITORING, METERING AND/OR CONTROL, THEN SPIRAX SARCO CANADA CAN HELP YOU FIND THE ANSWER!

PHONE FOR YOUR GUIDE TO IMPROVING PLANT PROCESS AND ENERGY EFFICIENCY.

(905) 660-5510 Ask for Carol

ISA's Mission

To be the foremost worldwide society with the science and application of measurement and control technologies, and to advance members' competence, professionalism, and recognition.



HARDIE INDUSTRIAL SERVICES INC.

Representing...

GGOSCO
Custom Ball Valves

KINETROL
Actuators



Dwyer[®]
INSTRUMENTS INC.

Instrumentation/Electrical Installations • Process Design • Project Management
Contract Maintenance • Sales & Service

Phone: (519) 649-1433 Fax: (519) 649-6559
London, Ontario



Technology Works!

In Process Measurement Systems



• Ultrasonic Level Measurement



• Belt Scales/Flowmeters



• Flow/Equipment Sensors



• Motion Sensors

Milltronics offers products for non-contacting ultrasonic level measurement for solids and liquids at ranges up to 60 m; single and multi-idler conveyor belt scales for weighing material moving on conveyor belts; dry solids flowmeters for continuous in-line weighing; and process protection equipment including flow/no flow switches and motion sensors.



1954 Technology Dr., P.O. Box 4225
Peterborough, Ontario K9J 7B1
Tel: (705) 740-2431 Fax: (705) 745-0414

BSP INSTRUMENTS

Southwest Ontario Representatives for

DRESSER/HEISE

Mississauga
(905-826-8411)

G.L. STEBBINS CO.

London
(519-455-1350)

INDUSTRIAL TECH SERVICES

Mississauga
(1-888-487-8677)

Pressure Calibrators - all N.I.S.T. traceable,
hand-held, digital, transducers, deadweight

Smar - pressure & temperature transmitters
- fieldbus, PLC's, boiler control

Cdn. Meter - gas metering, regulation, correctors

Flo-Lin - venturies, orifice plates, flow nozzles

Sol/Pratt - cryogenic & pyrogenic valves

Kent - water metering

Ruskin - dampers, louvres, actuators

Eurotron - portable combustion analyzers

- calibrators f/ temperature, V., mA...

JUM - THC analyzers including non-methane

Babbitt - baghouse & dust emission monitors

- RF & ultrasonic level monitors

Protek - MME's, scopes, power packs

For Details on Above Contact:

B.S.P. INSTRUMENTS, Wallaceburg, Ontario

Tel: 519-627-8505 • Fax: 519-627-7016 • Email: BSP@kent.net

John E. Eydt, CET

LANGTREE CONTROLS LTD.

P.O. Box 2326
509 South Vidal Street
Sarnia, Ontario
N7T 7S6
Phone: (519) 344-6868
Fax: (519) 344-7944
E-Mail: langtree@sarnia.com



INSTRUMENT & ELECTRICAL DESIGN ENGINEERING

Services

Feasibility Studies
Budget Preparation
Detailed Engineering
Project Management
Field Co-ordination
AutoCad / Microstation PC

Experience With

Control Panel Design / Layout
Instrument Installation Details
Marshalling Rack / Field Wiring
MCC Design / Layout
Motor Control & Protection
Variable Speed Drives

THE "ROOT" TO QUALITY ENGINEERED CONTROLS !



romatec

1173 Michener Ct., Unit #1
P.O. Box 2110
Sarnia, Ontario N7S 5G5
Tel.: (519) 337-7416
Fax: (519) 336-0998
Inwatts: 1-800-268-3137

Serving Canada's Process Industries Since 1955

ASHCROFT®

- Pressure Gauges

 **JACOBY-TARBOX**

- Sight Flow Indicators

Bellofram

- Transducers
- Regulators

 **MONITOR LABS**

- Opacity Monitors and Combustion Analyzers

 **BS&B**
SAFETY SYSTEMS

- Rupture Discs

 **Pulsafeeder**

- Metering Pumps

 **DELPHIAN**

- Combustible Gas Monitors

ROSEMOUNT®

- Combustion Controls

 **JERGUSON®**

- Liquid Level Gauges
- Eductors

TN Technologies
Kay-Ray

- Radar, Nuclear & Ultra-sonic Level Controls

Also...

APOLLO • ITT • KOCH • 3P • TBV

GIVE 'EM HELL.



UNITED ELECTRIC PRODUCTS ARE BUILT TO TAKE IT.

Look to us for pressure and temperature switches, temperature sensors, transmitters and thermostats that meet your most demanding requirements in your most demanding environments. Our new product innovations include epoxy coating for wider NEMA 4/4X and corrosive locations, flush mount and ultra low pressure all welded pressure sensors as well as corrosion resistant pressure transmitters. A diverse growing line to meet your exacting specifications.

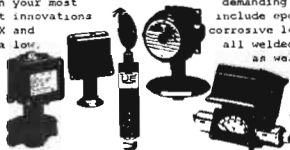

QUALITY LIKE THIS IS NO EMPTY PROMISE.
PUT US TO THE TEST.
Call United Electric Controls at 905/625-5082.

United Electric Controls (Canada) Ltd. Tel: 905/625-5082 Fax: 905/625-5709



ALL NEW FOR 1998!

It's easy to receive a FREE copy of Transcat/E.I.L.'s new, comprehensive, full-colour 1998 Catalogue of Test, Measurement, and Calibration Instruments.

Just call us at 800-828-1470.

TRANSCAT/EIL

*Industry's First Choice for Test, Measurement,
and Calibration Instruments and Services*

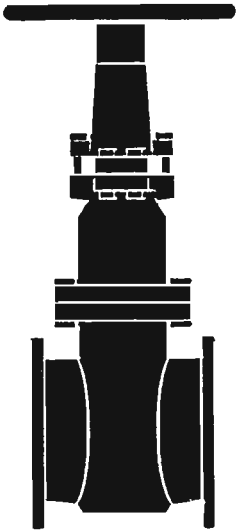

Professional Valve Service Ltd.

Quality Service For Over 25 Yrs.

859 Ontario Street, N7T 1N1

P.O. Box 761 Sarnia, Ontario N7T 7J7

Tel: (519) 336-3933 • Fax: (519) 336-6157



*– The Complete Shop and
Mobile Valve Service –*

24 HR SERVICE

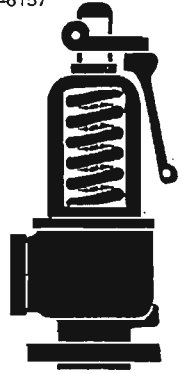

Campbell Scientific (Canada) Corp. Data Acquisition

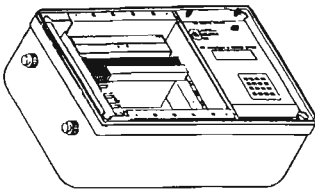

CR7

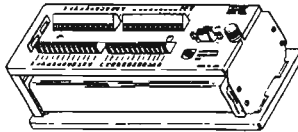

CR10

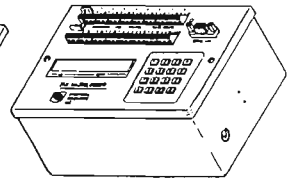

21X

**MEASURING: Temp Probes. Load Cells. Relays. Flow Meters. 4-20mA Transducers
Strain Gauges. Analog. Digital. Pressure Transducers. Meteorological Sensors**

On Site Demonstrations Available

Est. 1978

192 st clair str. chatham, ontario N7L 3J6 (519) 354 7356 fax (519) 354 1558
11564 149 str. edmonton, alberta T5M 1W7 (403) 454 2505 fax (403) 454 2655



PROSIGMA

Process Analyzers-Analyseurs de procédés

Elsag Bailey Analytical Division



Opacity Monitors
In-Situ CEM Systems
Combustion Monitors
Cross Stack CO Analyzers
UV/IR Process Photometers
Portable Flue Gas Analyzers

BOMEM

Process FTIR Analyzers
Extractive FTIR CEM Systems



Delta F Corporation

Oxygen Analyzers

zellweger analytics

astro TOC Analyzers

polymetron pH, Conductivity,
Silica, Oxygen, Sodium,
Chlorine, Ozone, Hydrazine,
Phosphates, Nitrates, Titrators

BTG polymetron Turbidity Analyzers
Suspended Solids Monitors



Innovative Sensors, Inc.

Industrial pH/ORP Sensors



Shamrock Transportable CEM Systems
Environmental Low Cost CEM Systems

AEM SYSTEMS

Sampling Systems for
Liquid and Gas : Process,
Effluent, Boiler Feedwater,
Ambient Air and Emission

PROSIGMA ANALYTICS INC.

Toronto

4141 Dixie Road,
PO. Box 61
Mississauga
Ontario L4W 4X9
Tel.: 905 206 0921
Fax.: 905 206 1361

Montréal

1051 Ave. St-Charles,
Suite 106
Vaudreuil-Dorion
Québec J7V 8P5
Tél.: 514 455 8185
Fax: 514 455 8984

Dräger

Gas Detection

Stationary Systems

Toxic Gases and Vapours

CO, H₂S, CL₂, CO₂, NH₃, O₂
HCL, HCN, NO₂, PH₃, SO₂
and many others

Combustible Gases

Methane, propane, solvents;
over 400 different gases



Portable Monitors

Single and multi-gas monitors;
Evaluate worker exposure;
Confined space entry



Dräger Tubes

Detect over 500 different gases
quickly, simply, accurately



Dräger CMS

Revolutionary measurement system,
gas testing on a Chip

Draeger Canada Ltd.

7565 Danbro Crescent
Mississauga, Ontario L5N 6P9
Tel. 905-821-8988 Fax 905-821-2565

TRILLIUM

Measurement
And
Control

2600 John Street, Unit 217
Markham, Ontario L3R 3W3

**FISHER-ROSEMOUNT PETROLEUM — TURBINE, POSITIVE DISPLACEMENT
FLOWMETERS AND VALVES**

ELDRIDGE PRODUCTS — INLINE AND INSERTION THERMAL MASS FLOWMETERS

FLOW & LEVEL CONTROLS — ELECTRONIC FLOW AND LEVEL SWITCHES

**SERVICE AND CALIBRATION — NIST, NRC TRACEABLE GAS AND LIQUID
FLOWMETER CALIBRATIONS**

ALSO AVAILABLE: TEMPERATURE MEASUREMENT, R.F. LEVEL MEASUREMENT, PRESSURE GAUGES

Phone: (905) 305-7790

1-800-246-9920

Fax: (905) 305-7791

WIKA

WIKA INSTRUMENTS CANADA LTD.

Pressure, Vacuum and Specialty Gauges
Pressure Transmitters and Transducers
Digital Indicators, Chemical Seals



Precision General Inc.

TREND Instruments, Inc.



- Needle Valves • Block and Bleed Valves • Mini Valves
- Manifold Valves • Direct Mount Manifold Systems

145 Mayfair Dr., Sarnia, Ontario N7S 1L3
TEL: (519) 344-1339 FAX: (519) 344-1339

- Bimetal Thermometers
- Gas and Vapor Actuated Thermometers
- Thermowells

1535 Meyerside Dr., Unit 6, Mississauga, ON L5T 1M9
TEL: (905) 795-1677 FAX: (905) 795-1669

HURON VALVE & FITTING LIMITED



P.O. Box 386
Sarnia, Ontario N7T 7J2

JOE LAWLESS
ED VANDEN EYNDE
RANDY HADDON
BRIAN DAVIDSON

Phone: (519) 336-3453
Fax: (519) 336-1537

⋮
Choosing a safety system isn't a decision
to be taken lightly



With so many people affected by the safety system you select, it can be tough finding a critical control system that fits your budget and gives you peace of mind that you made the right decision for everyone's future.

The traditional choices include triple modular redundant (TMR) systems or programmable logic controllers (PLCs). TMR systems have a reputation for high availability and safety, yet the cost can be prohibitive. PLCs cost less, but the potential for a dangerous failure may be more risk than you're willing to take.

The QUADLOG critical control system includes features such as quad redundancy and proven fail-safe operation to give you the availability and safety of TMR at a lower cost. This unique combination takes away the worry that your budget might compromise your plant's safety.



QUADLOG: High safety at a lower cost

⋮
MOORE PRODUCTS CO. (CANADA) INC., P.O. Box 370, Brampton, Ontario L6V 2L3
Phone: (905) 457-9638 Fax: (905) 457-4182



Moore Products Co.



CB ENGINEERING (EASTERN) LTD.

P.O. Box 2523
Sarnia, Ontario N7T 7H9
Tel: (519) 337-1350
Fax: (519) 337-3105
Sales & Service: 1-800-99-CBENG

OFFICES ACROSS CANADA
• CALGARY • SARNIA
• EDMONTON • TORONTO
• MONTREAL • VANCOUVER
• WINNIPEG



BLH Electronics Canada

FORCE AND WEIGHT MEASUREMENT.
BATCH/WEIGHT CONTROL SYSTEMS.
WEB TENSION MEASUREMENT & CONTROL.



INDUSTRIAL FIRE & GAS DETECTION SYSTEMS
HAZARD EVENTS MONITORING.
SLICKWATCH OIL SLICK DETECTOR.



ORIFICE PLATES, VENTURIS
FLOW TUBES, METER RUNS
FLOW NOZZLES

Intellution

PC BASED SCADA & MMI SOFTWARE FOR
32 BIT WINDOWS APPLICATIONS.
PC BASED REAL-TIME CONTROL SOFTWARE.



HIGH ACCURACY MAGNETIC LIQUID LEVEL
TRANSMITTERS.
SEAL FLUID SUPPLY TANKS (SEAL POTS).



PC BASED INDUSTRIAL AUTOMATION
SYSTEMS
INTELLIGENT MODULAR I/O



PC BASED REAL TIME CONTROL



KEYBOARD, VIDEO, MOUSE (KVM)
CONTROL AND ACCESS PRODUCTS



TURBINE METERS.
LOW FLOW METERS (0.001 GPM).
CALIBRATORS/FLOW PROVERS.



INDUSTRIAL COMPUTERS AND MONITORS
DATA COLLECTION SYSTEMS.



VORTEX/MASS/MAGNETIC FLOWMETERS.
RECORDERS/CONTROLLERS.
PRESSURE/TEMPERATURE TRANSMITTERS.
O₂/pH/ORP/D.O./CONDUCTIVITY ANALYZERS.



INSULATED/HEATED INSTRUMENT
ENCLOSURES.
INSULATED/HEATED TUBING BUNDLES.



WIN 911 - ALARM REPORTER
EASYLINK - FACTORY FLOOR CONNECTIVITY
TO WINDOWS

YOKOGAWA

PROGRAMMABLE CONTROLLERS
PANEL MOUNT INDICATORS & SWITCHES

Visit our Web Site: <http://www.cbeast.com>

OVANTUM SALES INC.

6 Guildford Court, London, Ontario N6J 3Y1
Phone: (519) 474-3044 Fax: (519) 471-7640

MANUFACTURER'S AGENTS for

RAMSEY CANADA
KISTLER-MORSE
QUALITY CONTROL EQUIP.
BURKERT
FUJIKIN of AMERICA INC.
HARWIL CORP.
PRECISION DIGITAL CORP.

INGREDIENT MASTERS
KUEBLER CONTROL ENG.
BARBER ENG.
B/W CONTROLS
GH FLOW AUTOMATION
MADISON CO.
JGG CONTROLS

*Specialists in Sampling, Weighing, Flow & Level Measurement and Control
of Solids, Liquids and Slurries*

Omnitronix

Division of RHC and Associates Inc.

*Your Instrument
Headquarters*

- | | | |
|---------------|---|---|
| [] AOIP | ▶ | Calibrator, Data Acquisition, Micro-ohmeter, Thermometers |
| [] DAVENPORT | ▶ | Melt Viscometers, Friction Testers, Density Gradient Columns, MFI |
| [] GP:50 | ▶ | Pressure Transducers |
| [] KYORITSU | ▶ | Clamp-on Ammeters, Insulation Testers |
| [] KYOWA | ▶ | Strain Gages, Load Cells, Amplifiers, Recorders |
| [] LLYOD | ▶ | Universal Testing Machines (tension, etc.) |
| [] RUSTRAK | ▶ | Data Loggers, Harmonic Loggers, Strip Chart Recorders |
| [] TEKTRONIX | ▶ | Oscilloscopes, Power Supplies, Function Generators |
| [] WEST | ▶ | Temperature Controllers / Pressure / 4-20mA |

Omnitronix

Division of RHC & Associates

2180 Dunwin Drive, #4, Mississauga, ON L5L 1C7
Tel #: (905) 828-6221 Fax #: (905) 828-6408



CTH INDUSTRIAL CONTROLS ONTARIO LTD.
 45 Bramalea Road Suite 210 Brampton Ontario L6T 2W4
 Telephone (905) 792 6829 Fax (905) 792 6902



ACTION INSTRUMENTS

- Limit Alarms
- Signal Conditioners
- Transmitters
- Indicators

AFE Technologies Inc.

- Touch Screens
- Graphic Display Systems
- Databpanels



- Pressure Switches
- Temperature Switches
- Flow Switches
- Pressure Transducers

DIXSON, inc

- Indicating Bargraphs and Alarms
- Horizontal and Vertical Units
- Programmable Configurations
- Nuclear Qualified Indicators



- Weight Controllers
- Rate Controllers
- Batching Systems
- Load Cells



- Corrosion Proof Thermoplastic Products
- Manual & Actuated Ball Valves
- Manual & Actuated Butterfly Valves
- Single and Duplex Bag Filters



SEMITRONIC

- Frequency Transducers
- Current Transducers
- Voltage Transducers
- Hall Effect Sensors



- Industrial Computers
- Shoebox Computers
- Operator Workstations
- CPU Boards 486 P5



- 4 Point Annunciators
- Process Meters
- 8 Channel Scanners
- Loop Powered Meters

**PKC POWERS
 PROCESS CONTROLS**

- Single and Dual Loop Controllers
- Auto/Manual Control Stations
- Recorders



- On line Non Contact Temperature
- Portable Non Contact Temperature
- Multi Point Non Contact Scanner
- Two Colour Temperature Measurement



- DC Voltmeters
- Process Monitors
- Frequency Meters
- Counters



- Signal Conditioners
- Power Supplies



YOUR ISA MEMBER BENEFITS

You receive many benefits as an ISA member. In addition to developing valuable contacts with others in the instrumentation field through **Section Activities**, ISA offers . . .

Division Activities—An opportunity to join any of 24 technical interest divisions that keep you current in your particular field.

Directory of Instrumentation—A free annual guide of products, manufacturers, services, trade names, sales offices and more.

Standards and Practices—International industry guidelines that help improve performance and communication, reduce costs and promote safety. Free as issued.

Leadership Development—Educational programs and materials designed to enhance your leadership skills in preparation for Society and career advancement.

Instrumentation Publications—Over 400 publications and educational aids available at member discounts.

INTECH—The leading international journal of instrumentation that keeps you up to date every month— free.

Inside ISA—A free publication supplement that highlights member activities.

Technical Training Courses—An opportunity to update your technical skills at member discounted rates.

Symposia, Conferences, Exhibits—Forums that allow you to discuss practical applications with engineers, scientists, educators, researchers and technicians.

Peer Recognition—ISA honors and awards that acknowledge outstanding achievements.

Resume Referral Service—Free employment assistance to unemployed members.

Optional MasterCard, Insurance—An opportunity to get a MasterCard or sign up for supplemental insurance at low group rates.

FOR MORE INFORMATION ON ISA MEMBER BENEFITS, CONTACT:

Instrument Society of America

67 Alexander Drive, PO Box 12277 • Research Triangle Park, NC 27709 • (919) 549-8411



ControlAir Inc.



J.M. CANTY, INC.



PRODUCTS

- ACTUATORS
- AIR CYLINDERS
- ANNUNCIATORS
- BLEEDER CLEANERS
- BTU METERS
- CAMERA SYSTEMS
- CONTROL VALVES
- CONTROLLER (Batch)
- CONTROLLER (Pressure)
- CONTROLLER (Temp.)
- CONTROLS
- DIGITAL PROCESS INDICATOR
- ELECTRIC ACTUATORS
- FLOW INDICATORS
- FLOW MONITORS
- FLOW METERS
- FLOW SWITCHES
- FLOW TOTALIZERS
- FLOW TRANSMITTERS
- GRAPHIC DISPLAY INDICATORS
- INSTRUMENT AIR FILTER REG.
- ISOLATORS
- LEVEL INDICATION-CONTROL
- LIGHTING (Vessel)
- PIPE SPREADER
- PRESSURE BOOSTERS
- PRESSURE CONTROLLER
- PRESSURE INDICATORS
- PRESSURE REGULATORS
- PRESSURE SWITCHES
- PRESSURE TRANSDUCERS
- PRESSURE TRANSMITTERS
- REGULATORS
- RTD's
- SIGNAL CONDITIONERS
- SIGNAL CONVERTERS
- SIGHT GLASSES
- TEMPERATURE INDICATORS
- TEMPERATURE CONTROLLERS
- TEMPERATURE SWITCHES
- TRANSDUCERS
- TRANSMITTERS
- THERMOCOUPLES
- VISION SYSTEM (Camera)
- VALVE ACTUATORS
- VALVES (Backpressure Relief)
- VALVES (Control)
- VALVES (Regulators)
- WIND SPEED MONITOR

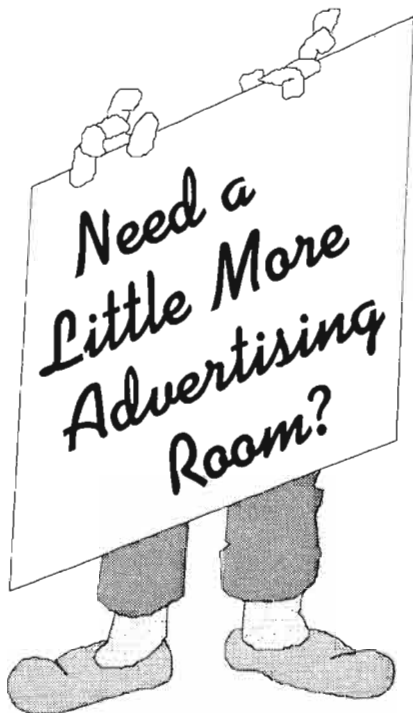

Contact the Newsletter Team for Details!

6 LANSING SQUARE, SUITE 120
NORTH YORK, ONTARIO M2J 1T5
PHONE: (416) 499-8904
FAX: (416) 499-5381



**The International Society
for Measurement and Control**

ISA Student Section



It has been business as usual for the instrumentation students here at Lambton College and I trust that everyone enjoyed their summer holidays and are back hard at work. As you are probably already aware, this is the sixth and final term for the students who began the instrumentation program back in September of 1994, and from first hand experience we have come a long way. Finally all of the tests and lab write-ups that have been submitted over the years are about to pay off. We are looking forward to a field trip which Brad Sarson, Student Section Vice-President, has arranged. On November 12, 1997, the students will have the opportunity to tour the Rockwell Automation facilities in Cambridge, Ontario. I am sure this will be a very interesting and informative experience for all that participate.

On behalf of the ISA Student Team I would like to thank the Sarnia Section Executive and SAC office from Lambton College for their financial support in sending us to participate in the ISA 1997 Student Competition in Anaheim, California. We would also like to thank Mike Grey, team faculty advisor, for all the time and effort he spent coordinating



the trip. The trip was a success for everyone who was involved. There were ten teams that participated in the competition, three from Canada, six from the United States, and one from Russia, which truly made for an international event. Special mention should be given to the team from St. Petersburg, Russia, for demonstrating their keen interest and knowledge in the field of instrumentation. Our team from Sarnia had an unofficial fourth place finish overall. The ISA Tech '97 show was an interesting display of all the latest and greatest advances in instrumentation. As a team we were able to attend the show and establish a number of job contacts. The Sarnia Team members included Ken Pollock, Bryan

Berry, Andrew Jenniskens, Steve Vouzoukos, and myself (Joe Steele). This year the ISA distributed the prize money equally among ten teams. A portion of this years proceeds has been donated towards the support of the 1998 Sarnia Student Team.

At this time, on behalf of myself, and the rest of the forthcoming graduating student members, I would like to thank the Sarnia Section for all their help and support to the Student Section. It has been a great experience for myself to be involved in the ISA association and I hope to continue as a full time member upon graduation. Hope to see you at the next ISA Dinner Meeting. Once again, Thank -You.

Joe Steele, *Student Section Newsletter Editor*

ARMATEK CONTROLS LIMITED

PROCESS INSTRUMENTS SALES & SERVICE

ARMATEK	- Instrument Accesories, Custom Treatment Panels
CELLEX	- Instrument Heating Specialists, Tubing Bundles
DELANV	- Level Instrumentation
FLUID DATA	- Refinery Analyzers, Gas Chromatographs
GREAT PLAINS	- Digital Flow Meters
ITT BARTON	- Industrial Pressure and Flow Instruments
MESA/NUSONICS	- Sonic Interface Detectors, Flow Meters & Analyzers
MIKRON	- Non Contact Temperature Measurement
MOORE INDUSTRIES	- Electronic Modules, Interfacing Solutions
OIL GEAR	- Flow Measurement Products
PHASE DYNAMICS	- Microwave Process Analyzers
ROHRBACK COSASCO	- Corrosion Monitoring
TELEDYNE ANALYTICAL	- Gas Analyzers
THERMO ELECTRIC	- Thermocouple, RTD Specialists

SARNIA OFFICE - Phone: (519) 332-0100 Fax: (519) 332-8821

TORONTO OFFICE - Phone: (416) 251-3111 Fax: (416) 251-1951

Serving the Process Industries Since 1966

NEW PC-Programmable Temperature Transmitter

From one configuration window in one minute, you can set up our new universal.

TRY PC-Programmable Temperature Transmitter.

As simple as point-and-click, now you don't have to give up simplicity to get versatility.

- Handles 23 RTD types, 9 thermocouples, potentiometer, mV, and ohm inputs.
- Scaleable 4-20mA output is linear, stable, and accurate.
- 2 Wire (loop-powered) in hockey-puck field-mount and DIN rail mount housings.



- Fast measurement cycle (up to 8 times per second) delivers analog speed with digital power and flexibility.

- Stops ground loops with signal isolation up to 1500Vrms.

- Patented Total Sensor Diagnostics detects sensor problems, then provides error messages that stop guesswork and slash troubleshooting time.



FREE Windows® Configuration Software, with online Help system, smoothly guides you through set up.

 **MOORE INDUSTRIES**

Tel: (818) 894-7111
Fax: (818) 891-2816

One Telephone Call:
1-800-999-2900

The Interface Solution Experts

ISO 9001 Certified!



#A2876, #FM 24612, SFPULVEDA, CA, USA
#FM 13498, UNITED KINGDOM
All product names are trademarks of their respective companies.

EXAM SCHEDULE

for the Certified Control Systems Technician (CCST) Program

1997 - 1998 Exam Locations

City, State	Facility
Alvin, TX	Alvin Community College
Atlanta, GA	Atlanta Electrical JATC
Bangor, ME*	New England Controls
Boston, MA	Electrical Industry Training Center
Chattanooga, TN**	Chattanooga Electrical JATC
Chicago, IL	UA Local 597
Dearborn, MI	Henry Ford Community College
Denver, CO	Colorado School of Mines
Los Angeles, CA	California Polytechnic University
Parsippany, NJ	IBEW Local 102
Pasco, WA	Columbia Basin College
Philadelphia, PA	Williamson Trade School
Pocatello, ID	Idaho State University
Portland, OR	Wacker Siltronic Corporation
Portsmouth, OH	Shawnee State University
Research Triangle Park, NC	ISA Training Institute
St. Louis, MO	Missouri Technical School
Toronto, Canada	George Brown College
Trinidad, West Indies	Ramdass School of Computing Intl.Ltd.
Tulsa, OK	Tulsa Technology Center

1997 Exam Dates

October 18, 1997	Levels I, II & III
December 6, 1997	Levels I, II & III
February 7, 1998	Levels I, II & III
May 2, 1998	Levels I, II & III

Application Deadline

August 27, 1997
October 22, 1997
December 17, 1997
March 1, 1998

* The exam site at Bangor, Maine will offer the examination only on the following days: October 17 and December 5, 1997.

** Chattanooga, Tennessee is offering the examination only on October 18, 1997.



INSTRUMENT ENCLOSURES & HEATERS

- SINGLE AND MULTIPLE TRANSMITTER INSTALLATIONS
- CUSTOM ANALYZER ENCLOSURES
- CUSTOM SAMPLE SYSTEM ENCLOSURES
- MODULAR INSTRUMENT HOUSINGS
- "SMART" TRANSMITTER ENCLOSURE
- COMPUTER HEAT CALCULATIONS
- CAD LAYOUT OF INSTRUMENTS
- RETROFIT FIELD REPLACEMENTS
- 100% CANADIAN (SARNIA) MANUFACTURED

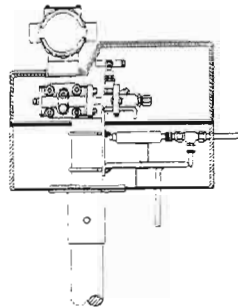

distributed by:



Sarnia Piping Specialties Ltd.

765 EVETT STREET. P.O. BOX 2018
SARNIA, ONTARIO N7T 7L1
(519) 336-8820 FAX: (519) 336-2033

SARNIA PIPING SPECIALTIES LTD.,

765 EVETT ST. P.O. Box 2018, Sarnia, Ontario. N7T 7L5

Phone: 336-8820 Fax: 336-2033

- OLIVER VALVES
- BI-LOK FITTINGS
- GO REGULATORS
- BALSTON FILTERS
- STATHAM TRANSMITTERS
- SPS FIBRE FORM ENCLOSURES
- SCHLUMBERGER FLOW METERS
- ITT NEO-DYN PRESSURE SWITCHES
- MANOUBOURDON PRESSURE GAUGES
- ITT CONOFLOW TRANSDUCERS & REGULATORS

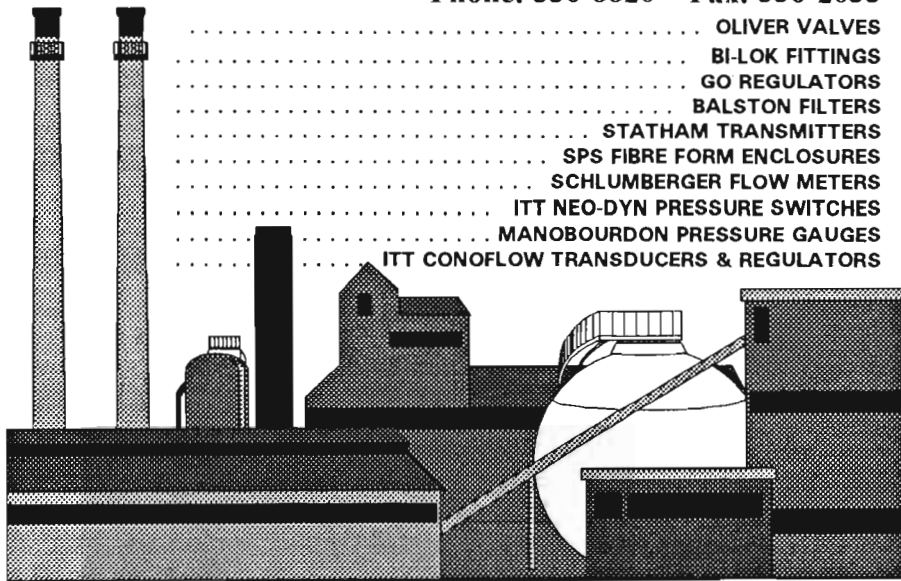

CONTRO VALVE INC. SERVICE & REPAIR CENTER

Contro Valve Inc. is your exclusive Dresser authorized full service MARC/GTC® Repair Center for all of your control and relief valve repair needs.



MARC Program - Masoneilan Authorized Repair Center

- Complete in-house or on-site repair or overhaul of all control valves
- Field Diagnostic Testing Unit for in-line control valve analysis



GTC Program - Green Tag Center

- Complete in-house or on-site repair for all pressure relief valves
- Electronic Valve Tester (EVT) for in-place valve performance analysis
- Field Reseating Machine
- Set and test facilities for air, liquid and steam service

Contro Valve is your source for Dresser's Masoneilan®, Consolidated®, Hancock®, Dewrance® and Nilcor® valves and instrumentation.



CONTRO VALVE INC

907 Michigan Avenue, Pt. Edward, Ontario N7V 1H2
Tel.: (519) 344-4300 or Fax: (519) 344-0042

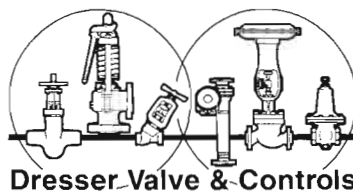

Dresser Valve & Controls

Past-Presidents of the Sarnia Section of I.S.A.

1946/47	Bill Graeb	1972/73	Everett Maness
1947/48	Amby Upfold	1973/74	Stan Thrift
1948/49	Ron Chamberlane	1974/75	E. A. Comello
1949/50	Don Livingstone	1975/76	Bernard West
1950/51	Amby Upfold	1976/77	Jim Henrikson
1951/52	Ken Goldring	1977/78	Jim Johnson
1952/53	Amby Upfold	1978/79	Ron Thurier
1953/54	Warren McKay	1979/80	Dave Braedley
1954/55	Jack Heatley	1980/81	John Stassen
1955/56	Larry Hall	1981/82	Wayne Jamieson
1956/57	Harold Kohlmeier	1982/83	Frank Bandura
1957/58	Ron Asselstine	1983/84	John Tranter
1958/59	Mike Hicks	1984/85	Robb Sharp
1959/60	Mike Hicks	1985/86	Ron Kells
1960/61	Mike Hicks	1986/87	Howie Whitton
1961/62	George Mills	1987/88	Joe Lobo
1962/63	Robert Brayne	1988/89	Irvin Hawkes
1963/64	Robert Newman	1989/90	Rich Paterson
1964/65	Robert Newman	1990/91	Ken Blair
1965/66	Ted Stock	1991/92	Jim Lomax
1966/67	Ted Stock	1992/93	Bob Kelly
1967/68	Bill Rion	1993/94	Bill Arundell
1968/69	Bud Dodds	1994/95	Larry Corbett
1969/70	Ray Wechselberger	1995/96	Mike Murray
1970/71	Bill Glendon	1996/97	Randy Dennie
1971/72	Curt McDonald		

ISO 9002 - 1994

Autotech
Balluff
Barber Colman
Carlo Gavazzi-Dupline
Danfoss
Dwyer
Dynapar
Eagle Signal



Davis Controls
LIMITED

TEL (905) 829-2000
FAX (905) 829-2630

London, Ont. Tel/Fax (519) 541-6953

Emco
Hycal
Klinger
Mercoid
Mitsubishi
NemaSoft
RTP
Uticor
Warrick

CANTECH

CANTECH CONTROLS

DIV. OF CANTECH CORPORATION

"Serving industry with dependable measurement and control equipment"

Sarnia Office

Phone - (519) 332-6162
Fax - (519) 332-3944

ANDERSON GREENWOOD - Instrument Manifolds, Gauge & Hand Valves, Metal/Soft Seated Spring Loaded & Pilot Operated Relief Valves, Rupture Disks

CANTECH SYSTEMS - Heat Tracing Controllers

CEMCO - Level Controls, Check Valves, Dump Valves, Throttling Valves

CHECKPOINT SYSTEMS - Chemical Injection Pumps

CUTLER-HAMMER - PB's, Starters, Contractors, VFD's, MCC's, Photo. & Prox. Sensors, PLC's
Electrical Distribution Products

CUTLER-HAMMER IDT - Man Machine Interfaces and Industrial Computers

DEVAR - Signal Conditioners, Transmitters, Indicators

DWYER - Gauges, Level, Pressure, Temperature & Flow Instruments, Valves

F.W. MURPHY - Level, Vibration, Temperature & Pressure Switch Gauges

G.H. FLOW - Turbine Flow Meters

GULF VALVE - Wafer Check Valves

INTEMPCO - Temperature Sensors, Transmitters, Thermowells

KEYSTONE - Ball Valves and Actuators

MICON - Compressor Control Systems

NEOTRONICS - Confined Spaced Monitors

OGONTZ - Temperature Control Valves, Steam Traps

OLDHAM - Portable & Fixed Gas Monitors, Laser Opacimeters

PENNY & GILES - Paperless Chart Recorders

RAYCHEM / CHEMELEX - Electrical Heat Tracing, Tracetek Leak Detection Systems, Monitoring Systems

REOTEMP - Bimetal Thermometers, Temperature Gauges

SCIENTIFIC LININGS & COATINGS - Weather Caps for Relief Valves

SKINNER - Solenoid Valves

STRAHMAN - Drain & Sampling Valves, Stem / Water Mixing Systems

WOOD - Flow, Level & Pressure Transmitters

Cantech also provides Service, Repair & Rental for our Relief Valves, Gas Monitors and Video Control Panel.

2 for 1 anyone?

Problem : You have one line to carry two 4-20mA signals, installing a new line is a hassle.

Solution : Key 90A/92A two channels/one line transmitter/receiver.

From: TechNorth Canada, PO Box 1082, Sarnia N7T 7K2
Tel. 541 1720 **Fax.** 541 1721 **E-Mail :** flk@mail.cwconnect.ca

Multi-function wiring devices save space, install faster, service easier.

Multi-function wiring devices from Phoenix Contact are designed to be a compact and cost efficient means of packaging many functions in today's space-efficient control systems — each function is packaged in only 1/4 inch (6.2 mm) width.

These DIN-rail mounted, modular blocks feature dead-front construction and captive screw-clamp termination for safe, reliable installation — in a snap. Phoenix Contact has the broadest line of multi-function wiring devices and feed-thru terminal blocks in the industry.

The grouping at right is only a sampling of the many application solutions available.

For application assistance, or a copy of our newest catalogue, call or fax.

PHOENIX CONTACT LTD.
235 Watline Ave.
Mississauga, Ontario L4Z 1P3
Phone: (905) 890-2820
Fax: (905) 890-0180

1-800-890-2820

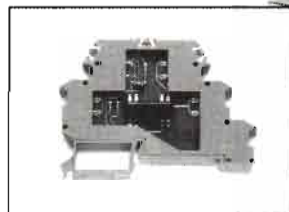

SMD technology allows relay isolation and contact ratings up to 3A in a terminal block only 1/4 inch (6.2 mm) wide.



Better space utilization for fused circuits.

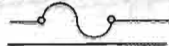

Three or four wire sensors.

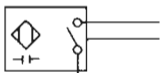

Fuse protection on analog signals.



Circuit testing or troubleshooting.



Thermocouples.

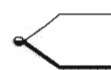

Status indication for current loops.



Relay isolation.

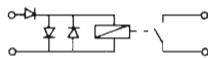

PHOENIX CONTACT

ISO 9002-
-1987



Cert #
#002077

MISSISSAUGA, ONTARIO

**PHOENIX
CONTACT**

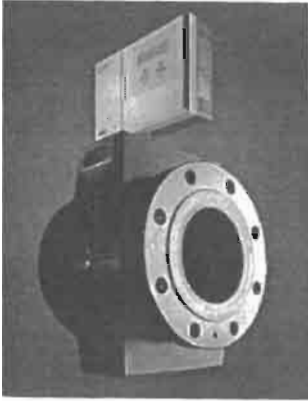

ABB

**The WORLD LEADER
in the Design and
Manufacture of
Industrial Process
Instrumentation.
Local Expertise and
Service.**

**Smart Transmitters
Magnetic Flowmeters
Recorders and Controllers
Water and Oxygen Analyzers
Gas Chromatographs
Infrared & Ultraviolet Photometers
ABB Extel Mass Spectrometers
Physical Property Analyzers for Refineries**

**For local service:
Phone (519) 541-0011
or fax (519) 541-0012**

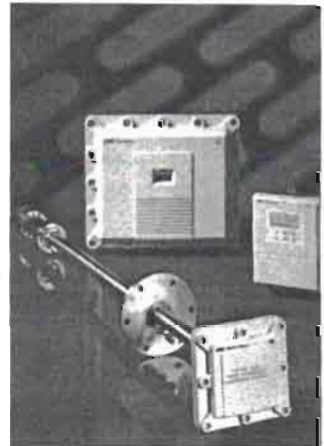

ABB

INDUSTRIAL PROJECTS LTD.

204-7100 Woodbine Ave.
Markham, ON L3R 5J2
Tel: (905) 477-0017 Fax: (905) 477-1495

Representing...

- Conant Controls Inc.**
- Selector Valves
 - Venting Valves
 - Stack Valves
 - Electric & Pneumatic Operators
 - Specials, Name Plates



THE ELECTRON MACHINE CORPORATION

- In-line Refractometers
- Black Liquor Analyzers
- Stock Consistency Transmitters
- Wire Gauges
- Beverage Analysis System



INTERNATIONAL SENSOR TECHNOLOGY

- Toxic and Combustible Gas Monitors



RONAN

- Annunciators, Temperature and Vibration Monitors, Two and Four Wire Transmitters, Lamp Cabinets, Graphic Displays, Motion Detection, Leak Detection, Intrinsically Safe Barriers, Calibrators, Sequence of Events, Recorder, Current to Pressure Transducers, P to I Convertors, Smart/Programmable 2 Wire Transmitters, Signal Conditioners, Isolators, Nuclear Measurement - Density, Level, Mass Flow and Weight

CCS

Custom Control Sensors, Inc.

- Pressure, Differential Pressure and Temperature Switches



KING INSTRUMENT COMPANY

- Flow Meters, Rotometers



TORBAR FLOWMETERS LTD.

- Pitot Tube Multiport Flow Meters



1401 Meyerside Drive, Unit A
Mississauga, Ontario
L5T 1G8

tel. (905) 564-3344
fax: (905) 564-3577
e-mail: info@imo.ca

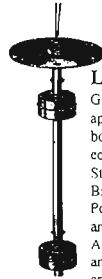

Level Switches

Gems Sensors offers CSA approved level switches, in both Single and Multi-Float configurations. Available in Stainless Steel, CPVC, Brass, Buna N., Polypropylene, Teflon, and Polysulfone materials. A wide variety of mounting and electrical configurations are also available.

SureSite

Gems Sensors offers CRN / ASME B31.1 or B31.3 approved Visual Magnetic Level Indicators. Pressures to 2650 psig (183 Bar). Temperatures to 750 degrees F (399 degrees C.). Available in Stainless Steel, PVC, CPVC, Polypropylene, PVDF, Hastelloy; or other exotic materials. Electronic Controls via CSA approved Switch Modules and / or Transmitters, rated for both Hazardous or non-Hazardous locations.

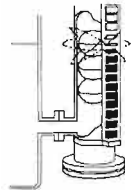

Flow Switches

Gems Sensors offers CSA approved flow switches, ideal for Nitrogen purge gas seal applications. Available in a wide variety of flow settings from 50 cc/min. to 100 gpm. Available in Stainless Steel, Rytan, Bronze, and Polypropylene. Rated CSA approved for both Hazardous and Non-Hazardous locations.

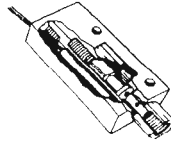

Level Transmitters

Gems Sensors offers CSA, UL, and FM approved level transmitters with 0-5VDC, 0-12VDC, and 4-20mA outputs. Available in a wide variety of lengths and process connections. Available materials of construction are: Stainless Steel, Brass, PVC, Polypropylene, and KYNAR. 1/2" and 1/4" Resolutions available. The best part, is no recalibration required.

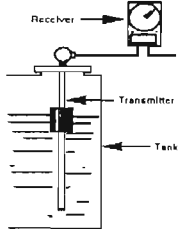

NOSHOK

Noshok offers gauges with accuracy's to ANSI 1A & 2A. Pressure ranges from Vacuum to 30,000 psi. 1-1/2" to 6" diameter dial faces. Available in ABS, Bronze, Stainless Steel, and Phenolic Case materials. NOSHOK will warrant, for "THREE YEARS", all 300, 500, 600, and 700 series liquid filled pressure gauges. Call and ask for a catalogue which details all the Gauge, Diaphragm, Bi-Metal Thermometers, and Needle Valves available.



ALPHA

CONTROLS AND INSTRUMENTATION

your partner in solving your
measurement and control problems.

- ★ SALES
- ★ SERVICE
- ★ CALIBRATION
- ★ REPAIRS

- ◆ Calibration & Measuring Instruments
- ◆ Controllers & Recorders
- ◆ Dataloggers
- ◆ Digital Process Meters
- ◆ Flowmeters
- ◆ Air Quality Instruments
- ◆ Humidity & Dew Point Instruments
- ◆ Intrinsic Safety Products
- ◆ Level Instruments
- ◆ Pressure Products
- ◆ Signal Conditioners
- ◆ Temperature Sensors & Transmitters

ALPHA

CONTROLS AND INSTRUMENTATION

361 Steelcase Road West, Units 5 & 6
Markham, Ontario L3R 3V8

Tel: (905) 477-2133 • Fax: (905) 477-4219

Toll Free: (800) 567-8686

Site Web: <http://www.alphacontrols.com>
e-mail: alphasales@alphacontrols.com

FLOYAL EQUIPMENT LTD

AND

PRESO FLOW METERING EQUIPMENT

COVER ONTARIO FOR YOUR FLOW REQUIREMENTS

JOHN A. SCHNURR
251 N. VIDAL ST.
SARNIA, ONTARIO
P- (519) 383 - 1225
F- (905) 669 - 4905

CONCORD - OTTAWA
SUDBURY - THUNDER BAY

New ISA members
have a lot to offer.



Make a point of introducing
yourself at the next meeting.

WESCO
the extra
effort people



DISTRIBUTION

INTRODUCING

FOR PRICING & TECHNICAL SUPPORT

TEL 1-800-547-4443

FAX 1-800-552-3339

VI & C
PRODUCTS

IOTRON CANADA, INC.

INTEGRATED ELECTROCHEMICAL SENSORS
For pH, ORP, and Ion Selective Measurements.



**Up to 10 Times Service Life
of Conventional Sensors!**

- Sensors can be integrated with a combination of thermocompensators, preamplifiers, batteries, transmitters, or solution grounds.
- Replacement sensors available for any transmitter, controller, recorder, PLC, or data acquisition device.
- Sensors standardized for most applications without additional cost.
- Service life up to 10 times longer than ordinary sensors.
- Iotron design advancements improve sensor performance, reduce maintenance, and lower operating costs.

SEND BROCHURE

Control

TYPE 500X ELECTRO PNEUMATIC TRANSDUCER (I/P, E/P)

- Output pressure from 3-100 psi
- Integral volume booster
- Low cost.
- Compact size.
- Agency approvals.
- Field reversible.
- Standard electrical inputs.
- Easy span and zero adjustment.
- Optional DIN connector.

TYPE 300 INSTRUMENT AIR FILTER

- Provides constant control of pressure under variable flow rates and supply pressures.
- High capacity, long lasting depth filter.
- Epoxy finish is standard.
- Self relieving.
- Low drop.
- Through body mounting.

SEND B

YOUR SINGLE SOURCE FOR COST I

WESCO

INDUSTRIAL CONTROL PRODUCTS

AirInc. ≡

EUMATIC

15 psig to 3-120 psig



R REGULATOR



ROCHURE

Pyro MATION, INC.

THERMOCOUPLES & RTD ASSEMBLIES

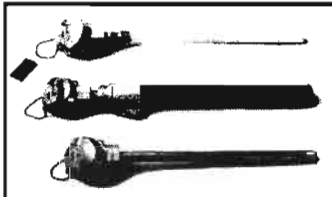

THERMOCOUPLES

SHEATH TERMINATION CONFIGURATIONS:

- RTD plugs and jacks.
- Standard screw cover and explosion proof heads.
- Miniature heads, leadwires.
- Special construction.

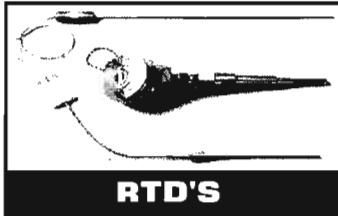

RTD'S

ASSEMBLY CONFIGURATIONS:

- Straight and angle.
- Single or double tube.
- Pipe extended.
- Union - nipple connected.
- Single or duplex element.



SEND BROCHURE

FOR FREE BROCHURE

THE BOX FILL IN HERE

Name _____

Company _____

Address _____

Tel _____

Fax _____

FAX 1-800-552-3339

EFFECTIVE CONTROL SOLUTIONS



SPEC (Sarnia) Limited

Specialty Process & Environmental Company

1550 Confederation Street, Sarnia, Ontario N7W 1A3
Tel: (519) 336-2405 • Fax: (519) 336-1177

FOXBORO

*The Intelligent
Automation People*

KLINGER LEVEL GAUGES

MIH PRODUCTS DIVISION
ITALIAN EQUIPMENT CO. INC.

*Responsive Supplier
Since 1987*

- Level and flow measurement
- Relief disc and vents
- Heat tracing expertise
- Environmental products
- Local inventory and EDI processing of orders

PROQUIP

- Line Blinds
- Check Valves
- Rupture Discs

Lc

Liquid Controls
Corporation

Absolute Accountability

MICRO WIRE PRODUCTS

(1980) LIMITED



THERMON

The Heat Tracing Specialists[®]

CELLEX

can ROSS

Can-Ross Environmental Services Ltd.

CAN-ROSS ENVIRONMENTAL PRODUCTS



SYBER SYSTEMS INC.

PRODUCT LIST

- MTL • Intrinsically Safe Barriers
- A. H. Emery • Hydraulic Load Cell Weighing Systems
- Fuller • Electronic and Pneumatic Liquid Filling Systems
- Hilcraft • IS Earth Proving Unit • for tanker trucks etc.
- RGS • Intrinsically Safe Valves
- Larod • Unique, Full-bore Valves and Instrument Isolators
- Expo Safety Systems, Purging and Pressurisation

For Div 1 and Div 2, the Mini-X and Mini-Z, Purge Systems are fully pneumatic in operation, and conform to North American Standards, NFPA 496-1993

They are acceptable to Ontario Hydro, for installation in Ontario.

TYPICAL APPLICATIONS

Computer Monitors & Terminals
 Programmable Controllers
 19" Rack Apparatus
 Panels & Switchgear.

Chart & Data Recorders
 Gas Analysers
 Motor Control Centers
 Condition & Monitoring.

SENTRY...

*The only name you need to know for
Sample Conditioning Equipment.*

- Sampling and analysis systems for fossil, nuclear and co-gen plants.
- Pre-engineered single point sampling stations.
- World's largest supplier of sample coolers.
- Unique rod in tube pressure reduction devices.
- Packaged cooling water systems.
- Precise temperature control units.
- Spiral Tube Heat Exchangers.



Sentry Equipment Corp.

Phone: 414-567-7256

Fax: 414-567-4523



Fryston Canada Incorporated

7370 Bramalea Road, Suite #30

Mississauga, ON L5S 1N6

Phone: 905-612-0566 or 1-800-387-7503

Fax: 905-612-0575

email: adelia@fryston.com

Complete Water Quality Monitoring Systems

From alkalinity to zinc —

*Hach's direct-reading instruments,
single-dose reagents, clear
instructions, and proven methods
make water testing convenient.*

- **Test Kits.** Over 200 single- and multiple-parameter water testing kits
- **Portable and Laboratory Instruments.** Reliable colorimetric, pH, ISE, and turbidimetric instruments that provide accurate results
- **Process Systems.** Complete on-line systems to monitor turbidity, pH, chloride, hardness, silica and more

HACH

Fryston Canada Inc.

7370 Bramalea Road, Suite #30

Mississauga, ON L5S 1N6

Phone: 905-612-0566

or 1-800-387-7503

Fax: 905-612-0575

email: adelia@fryston.com

The PLC vs the PC

This article is posted online for your convenience at:
www2.ebtech.net/~bsmith/plc-pc.htm

Have you heard that there is another alternative to the Programmable Logic Controller (PLC)? No it's not a DCS. It's a PC. A Personal Computer (PC) like the one on your desktop. Well, it could be but it tends to be more like an Industrial PC. There are a number of controversial issues because of the hardware and software required to perform the required functions.

The software issues tend to be the most controversial, especially operating systems and real time control. We all know that PLC's have dedicated proprietary operating and software systems. An Allen-Bradley PLC program does not run on a Modicon PLC and vice versa. The PLC programs run in a loop where the program executes from step one to the last step and back to step one and over and over. This is not the case with PC's. The operating system may run multiple parallel processes (threads) that may not all share equal processor (CPU) time.

The PC operating system (OS) may be the creation of Microsoft or another software company. Examples of Microsoft OS's are DOS, Windows 95[®] and Windows NT[®]. These OS's all have different characteristics. According to Microsoft, "Windows NT Workstation is the most powerful desktop operating system for the most demanding business needs. Users of mission-critical applications can take advantage of new 32 bit workstation solutions". Windows NT runs on the latest generation of microprocessors including Intel[®], Digital Alpha and MIPS[®]. It is a preemptive multi-tasking, multi-threading 32 bit operating system. BUT is it a real time operating system? What about the UNIX operating system that has been around for many years?

What is a real time OS? There are many definitions for real-time. The user has to determine what real-time means and define it to suppliers of hardware and software.

Examples of other software companies that make PC operating systems are QNX and SoftPLC.

Why is this an issue now? The price of PC hardware is falling, performance is rising and users are looking for standardized hardware and software that is easier to use and flexible. PLC programming software is also being standardized by meeting the IEC-1131-3 standard.

Online Articles

There have been many recent articles and information pages on the Internet about this subject.

Crossing PC/PLC Lines by Industrial Computing at:

<http://www.isa.org/journals/ic/features/jun97/pc-plc.html>

Control is migrating from the traditional PLC "black box" to a more software approach.

PC's in Control by Industrial Computing at:

www.isa.org/journals/ic/features/jun97/pc.html

PC-based control systems break the information barrier by letting you access and distribute data across the enterprise.

NT up Close by Industrial Computing at:

<http://www.isa.org/journals/ic/features/feb97/nt.html>

NT's strengths and weaknesses come to light when faced with the demands of industrial, real-time and embedded system development.

DCS, PLC or PC The System Decision by Control magazine at:

www.controlmagazine.com/0897/c044087.html

The PLC versus the PC by Forbes Magazine at:

www.forbes.com/forbes/97/0908/6005198a.htm

Who's in Control of the Factory Floor? By Industry.net at:

www.industry.net/news/pc_plc.htm

Software turns PC's into PLC's by Control Engineering Magazine at:

<http://www.manufacturing.net/magazine/ce/archives/1997/ct10801.97/08gcsr.htm>

(Continued on Page 47)

Real-time Control Systems:

NT versus UNIX is the wrong question by Chemical Processing Magazine at:

www.chemicalprocessing.com/protected/cp797/spot-1.shtml

There are several factors to consider when choosing an operating system, of which hard real-time performance is the major one. A Real Time Operating System (RTOS) must provide preemptive multi-tasking. Preemptive means that the OS can interrupt the execution of a task at any time and does not need the cooperation of the task itself. Multi-tasking means that it may choose to support multiple threads or processes. This article also addresses PC Reliability and Software fault Tolerance.

Real Time Encyclopedia web site at : www.realtime-info.be provides you with all the information you need about real-time issues.

Web Sites

The following company web pages contain product information:

Allen-Bradley	www.ab.com
ASAP Software	www.asapinc.com
Control Technology Corp.	www.control.com
Cuttler-Hammer	www.cuttler-hammer.com
GE Fanuc Automation	www.ge.com/gemis/gefanuc/
IO Works by VMIC	www.vmic.com
Nematron	www.nematron.com
PLC Direct	www.plcdirect.com
PLC Open (IEC 1131-3)	www.plcopen.org
QNX	www.qnx.com
SoftAutomation	www.softautomation.com/
SoftPLC	www.softplc.com
Steeplechase Software	www.steeplechase.com
Taylor Software	http://198.161.96.162/main.htm
Wizdom Controls	www.wizdom.com

References

1. "Is PC-Based Control For You?" by Cynthia M. Hollenbeck, presented at ISA Tech'97.
2. "IOWorks Base Package – Software Application Guide" by VMIC, Jan. 14/97. IOWorks™ is a suite of software components, compliant to IEC-1131-1 and Microsoft® new key technologies such as OLS and ODBC, that is available from VMIC to support the configuration, implementation programming, monitoring and control of data acquisition and control products. The IOWorks Base Package is a Windows NT™ operating system product designed to support the development of soft logic systems.
3. "Steeplechase Handbook : A Practical Guide to PC-Based Control and Flow Chart Programming" by Steeplechase Software. As PLC veterans, the authors of this Handbook experienced the frustrations of using proprietary PLCs. They understand your concerns about moving from PLC to PC-based control.
 - How did the PC come to replace the PLC for machine control?
 - What are the real benefits of PC-based control?
 - What are the differences between soft logic and hard real-time control?
 - How do I retrofit an existing PLC control system?
 - Why has flow chart programming become the standard language for PC-based control?
4. "Softlogic: Overcoming Funnel Vision". How and why IEC-1131 based SoftLogic frees the enterprise to become agile and profitable.

Brian Smith

email: bsmith@ebtech.net



Process Measurement - Control & Environmental Instrumentation

1045 South Service Road West, Oakville, Ontario L6L 6K3

Tel: (905) 847-2740 Fax: (905) 827-6984

E-mail: controls@cancoppas.com Internet: http://www.cancoppas.com

- | | | |
|-------------------------|-------------------|---|
| Valve | PMV | <ul style="list-style-type: none"> • Pneumatic & NEMA 4X or Class 1 Div 1 EXP or I.S. • Electro-Pneumatic Positioners • Quarter & Multi Turn Pneumatic Actuators • Position Transmitters & Limit Switches |
| Control | | |
| Environmental | Royce | <ul style="list-style-type: none"> • Interface Level - Total Suspended Solids Dissolved Oxygen - pH Fixed & Portable |
| Analytical | Epic | <ul style="list-style-type: none"> • Portable & Fixed Waste Water Sampler - Sludge Sampler |
| Safety | ADI | <ul style="list-style-type: none"> • Gas Sampling Pumps |
| | Crowcon | <ul style="list-style-type: none"> • Personal Portable & Fixed Site Gas Detection Systems |
| | Foxcroft | <ul style="list-style-type: none"> • Residual Chlorine - Turbidity - Chlorine Automatic Rate Control |
| | Regal | <ul style="list-style-type: none"> • Gas Chlorinators |
| Process | Stere | <ul style="list-style-type: none"> • Universal Programmable Indicators - Transmitters - Isolators |
| Conditioning | CRL | <ul style="list-style-type: none"> • Universal Programmable Bar Graph Indicators - Process & Temperature Controllers |
| Indication | RC Systems | <ul style="list-style-type: none"> • EXP Universal Transmitter - Universal Graphic Display / Alarm |
| Control | | |
| Data Acquisition | CEWE | <ul style="list-style-type: none"> • Electrical Measurement Transducers - Analogue Indicators |
| | Validyne | <ul style="list-style-type: none"> • P.C. Based Data Acquisition Cards Modular Signal Conditioners |
| Measurement | PMV | <ul style="list-style-type: none"> • Intelligent Valve Module |
| | Binmaster | <ul style="list-style-type: none"> • Rotary - Capacitance - Point On Demand Level Monitors |
| | FPP | <ul style="list-style-type: none"> • Oval Gear P.D. Flow Meters |
| | NICE | <ul style="list-style-type: none"> • Vortex Flow Meters |
| | Eldridge | <ul style="list-style-type: none"> • Thermal Dispersion Flow Meters |
| | KL Flow | <ul style="list-style-type: none"> • Pilot Tube - Venturi Flow Meters |
| | Kobold | <ul style="list-style-type: none"> • Flow - Level - Temperature - Pressure |
| | ICI | <ul style="list-style-type: none"> • Displacement - Incline - Acceleration |
| | Validyne | <ul style="list-style-type: none"> • Pressure |
| | Haven | <ul style="list-style-type: none"> • Process and Pressure Calibrators |
| Service | Cancoppas | <ul style="list-style-type: none"> • Service • Commissioning • Total Solutions - System Integration • Custom Engineering - Design |



Before you can understand customers' needs, you have to spend time in their shoes.

At Willer Engineering, we know each of our customers has unique requirements. So we put in the extra legwork to understand the application thoroughly. Then we back that up with consultation services, detailed technical information, product demonstrations and after-sales support.

It's all designed to ensure an ideal fit between our high quality process measurement and analysis products and our customers' long-term needs.

Send for our latest Product News Bulletin.



WILLER
ENGINEERING LIMITED

- | | | |
|---|--|--|
| Toronto
(416) 499-4421
Fax: (416) 499-0816 | Montreal
(514) 333-8555
Fax: (514) 333-4662 | Sarnia
(519) 336-3006
Fax: (519) 344-0607 |
| Dartmouth
(902) 469-4400
Fax: (902) 463-1010 | Sudbury
(705) 673-8900
Fax: (705) 673-8806 | |

ISA Sarnia Section "Dinner Meeting Notice"

Monday, November 24, 1997

Sarnia Golf & Curling Club

500 Errol Road West, Sarnia

Phone: (519) 336-2201

Cocktails 6:00 p.m. Dinner 7:00 p.m.

All Guests are Welcome!



GUEST SPEAKER

Ernie Higginson

Topic: Non-Contacting Level & Flow Management

M • E • N • U

Caesar Salad

•

Pickerel

•

Parsley Boiled Potatoes,
Vegetable Medley

•

Black Raspberry Parfait



** For special dietary needs contact Hilda White at the Sarnia Golf and Curling Club 48 hours prior to meeting date.*

NOTE: KINDLY BOOK BEFORE DEADLINE INDICATION

Please phone in your reservation by Thursday, November 20

to either Gayle at Provincial Controls... 336-7301

or Maureen at Willer Engineering... 336-3006

Members \$10 • Guests \$15

Note: ALL Members and guests are requested to reserve in advance. Please oblige... we need your support to plan your evening!

			LINE
			PROCESS
			CONTROLS

5310 FINCH AVE. EAST,
UNIT #2
SCARBOROUGH, ONTARIO
M1S 5E8
PHONE: ((416) 291-8525
FAX: (416) 291-9987

SARNIA REPRESENTATIVE

JIM ARMATAGE
TRENTEC, HARLEY



Precision regulators, boosters and relays
I/P, P/I or E/P transducers, Explosion proof I/P transducers
Motorized regulators



BETA[®] Calibrators for RTD, t/c, mA, mV, V, pressure & frequency
Promac[®] Signal Conditioners and Wodex power transducers
Industrial annunciators



S&J/L&J[®] servo, magneto-strictive and radar tank gauging technology
L&J[®] Smart encoder/level transmitters, and Tankway systems
S&J[®] Tank vents and flame arresters



Capacitance level controls for inventory control or high level
Vibration switches
Industrial control vales & SATRs



Solenoid valves in brass, stainless steel, and plastics
Piston and diaphragm vales
Sensors for level, flow, pH, ORP and conductivity

Who do you trust for your safety control systems? ICS-Triplex, that's who!

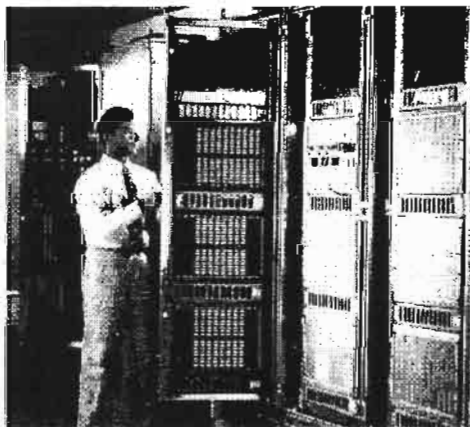

ICS-Triplex is a worldwide supplier of safety control systems with almost 30 years of experience in high risk process industries. We provide consulting services as well as turnkey design, engineering, manufacture, installation, commissioning and service of solid state, PLC and TMR technologies. Applications include shutdown systems, fire & gas systems and turbo-machinery control systems.

ICS-Triplex

16400-A Park Row

Houston, Texas 77084-5015

Phone (281) 492-0604, Fax (281) 578-3268

www.n-vision.com/ics

H C S

HEATING & CONTROL SYSTEMS

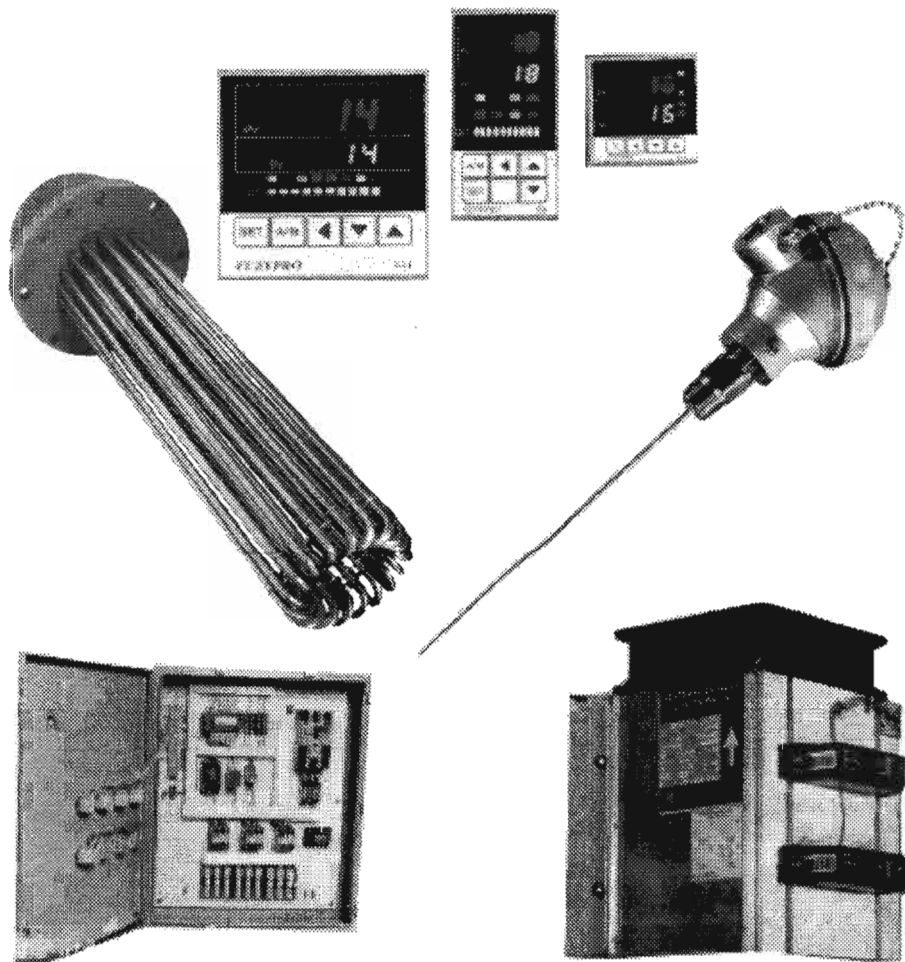

HEATERS, CONTROLS & SENSORS LTD.

HEATING & CONTROL SYSTEMS

117 Consortium Court, London, Ontario N6E 2S8

(519) 686-6095

NEW ISA GROUP INTERNET RATES

Our group account at Electro-Byte is finished. They do have a \$10/month for 10 hours with \$2/hour overcharge. Accounts are 3 months prepaid. A new Sarnia Industrial Professionals Group account is now in effect at Xcelco. This group includes all ISA members and others. There are a number of packages available. See below.

XCELCO INTERNET

SARNIA INDUSTRIAL PROFESSIONAL GROUP

NOVA Chemicals
 ICS - Industrial Computing Society
 PMAC - Purchasing Management Association of Canada
 IEEE - The Institute Of Electrical And Electronics Engineers Inc
 OACETT - Ontario Association of Certified Engineering Technicians and Technologists

ISA - Instrument Society of America
 PEO - Professional Engineers of Ontario

SPECIAL GROUP RATES

PACKAGE PRICING

Education Package \$ 8.95 /month 20 hrs/month : overtime \$.50 / hour
Basic Special Package \$24.95 /month 80 hrs/month : overtime \$.50 /hour

Once we have reached 50 customers online with XCELCO, group members may also choose the following option:

Group Special \$19.95 /month 50 hrs/month : overtime \$.50/hour

SETUP FEES

Basic Special	In home setup	FREE
Group Special	In home setup	FREE
Education Package	In home setup	\$20.00
	Set yourself up	FREE

** In home setup allows for 1 hour setup time, additional time will be billed at \$20.00 per hour.
 ** First months fee is payable to dealer at setup time.

EACH XCELCO INTERNET account includes:

- | | |
|---|--|
| ** Full access to the World Wide Web. | ** Full access to Internet News Groups. |
| ** Your own password and username. | ** Free local calling from areas listed below. |
| ** 2 free E-Mail accounts for sending and receiving messages worldwide. | ** Free personal home page (5 MB limit). |
| ** 1 Free scanning session to prepare your photos for a homepage. | ** Automatic Bank Draft Payment Plan. |
| ** CD Rom full of Internet software. | ** We Support USB X2 56K Technology. |
| | ** Coming soon Flex 56 Technology. |
| | ** Emailed monthly statements. |

XCELCO INTERNET provides free calling from the following areas:

Alvinston	Arkona	Bothwell	Camlachie	Brigden	Bright's Grove
Courtright	Corunna	Forest	Glencoe	Inwood	London
Oil Springs	Petrolia	Sarnia	Sombra	Warwick	Watford, Wyoming

Dealers are located Across Lambton County

DON BUSKO Camlachie 899-2774	MICRO-TECH Systems King St. Forest - 786-5775	COMPUTER HELP CENTER Forest - 786-6949	WHITCOM SERVICES James Whitney Sarnia - 337-0136
Arnold Black Inwood 898-2944	Daley Computer Watford 876-2737	MICRO-TECH Systems 464 N Christina Sarnia - 337-8181	MEGABYTES COMPUTER CENTER Glencoe - 287-5855

OUR SERVICE AND QUALITY ARE SECOND TO NONE!!!!

**** WE "XCEL" ****

1-888-WWW-XCEL CALL TOLL FREE 1-888-999-9235

NEWS RELEASE

REGIONAL PROCESS EQUIPMENT

Is pleased to announce our appointment as the NEW EXCLUSIVE REPRESENTATIVES for HEX Instrument & Gauge Valves.

Durabla Canada Ltd. is now being represented by REGIONAL PROCESS EQUIPMENT. Durabla offers Spring Assisted in-line check valve - designed to prevent water hammer. Meets or exceeds MSS SP-61 leakage requirements. Durabla also offers Duralon compressed gasket material, filled with PTFE and flexible graphite, giving you the right gasket for all your soft gasket needs.

NOVATECH

Novatech is pleased to announce our appointment as a distributor for Bacharach portable gas detection equipment. This line would include personal gas monitors, single and multi-gas detectors for gas utilities, combustible and toxic leak detectors and monitors and locators, portable area monitors, indoor air quality monitors and continuous area gas monitors.

Novatech is pleased to announce that Mrs. Colleen Glover, P. Eng. has joined the Novatech team as Project Coordinator. Colleen is an electrical engineering graduate from Concordia University and brings to Novatech over seven years experience in the field of technical support. Novatech wishes Colleen every success in this new challenge.

CUSTOM CONTROL SENSORS (CCS)

Effective July 1, 1997 all Custom Control Sensors (CCS) requirements for sales and service will be handled by:

Industrial Projects Ltd.

7100 Woodbine Ave., Suite 204, Markham, Ontario L3R 5J2

Tel: (905) 477-0017 • Fax: (905) 477-1495

ROSEMOUNT INSTRUMENTS

A new brochure, Presenting the Rosemount APEX Radar Gauge. Delivering Reliable Level Measurement, is now available from Rosemount Inc. The four page brochure describes the APEX Gauge's unsurpassed reliability and performance in process applications. For a free copy of Presenting the Rosemount APEX Radar Gauge. Delivering Reliable Level Measurement (reference number 00803-0100-1066), contact a Rosemount representative.

Rosemount introduces the Model 644 Smart Temperature Transmitter which uses digital technology and Application Specific Integrated Circuits (ASICs) to ensure high accuracy and signal integrity. The Model 644H installs in a connection head mounted directly on a sensor assembly, apart from a sensor assembly using a junction box or to a DIN rail using an optional mounting clip.

Rosemount Instruments

Are You Challenged...

- To do more with less
- To predict the future
- To achieve higher equipment reliability
- To maintain precise records

Introducing...



- Field-Based Architecture
- Asset Management Solutions
- Scalable Technology
- Easy-To-Use Interface

For Free Evaluation Call
1-800-268-1151

Visit Us At: <http://www.fisher-rosemount.com>

Customer Support Centre

Phone: 1-800-268-1151

Fax: 1-800-563-3051

Rosemount Instruments Ltd

581 VIDAL ST S
SARNIA ON N7T 2V8

FISHER-ROSEMOUNT™

Managing The Process Better.™

R.A. KIRBY SALES INC.

- SAAB TANK CONTROL - RADAR BASED LEVEL SYSTEMS
- MTS MAGNETOSTRICTIVE LEVEL SYSTEMS
- OPTEK PPM OIL/WATER, CONCENTRATION, COLOUR & TURBIDITY PHOTOMETERS
- EXACT FLOW DUAL ROTOR TURBINE FLOW METERS
- COLUMBIA SCIENTIFIC GAS ANALYZERS AND CEM SYSTEMS
- THERMAL MASS FLOW METERS AND PROBES
- ZIRTEK HIGH TEMPERATURE O₂ ANALYZERS

#100 - 3995 BATHURST STREET
NORTH YORK, ONTARIO M3H 5V3

TEL: 416-638-1080
FAX: 416-638-9389

SENSORS, SIGNAL CONDITIONING, DATA ACQUISITION & CALIBRATORS

SDR

interface
ADVANCED FORCE MEASUREMENT

PATRIOT

SENSORTECHNICAL

SENSIT

MASSA

Digifec.

EU



Durham Instruments

Products that measure. Service that measures up.

Toronto: (905) 839-9960
FAX: (905) 839-4325

Montreal: (514) 697-7054
FAX: (514) 697-4519

WebSite: www.dsensors.com
E-Mail: sales@dsensors.com

Westronics

Accelerometers
Chart Recorders
Data Acquisition Systems
Data Recorders
Encoders
Level
Linear Displacement
Load
Panel Meters
Non-Contacting Capacitive Gauging Systems

Macro Sensors™

Paperless Recorders
Portable Calibrators
Pressure
Rotary Displacement
Signal Conditioners
Slope/Tilt
Strain Gauges
Temperature
Torque
Ultrasonics
Non-Contacting Capacitive Gauging Systems

For all your sensing, control, acquisition
and calibration needs . . .

Call us Today!
1-888-D.I.SENSOR

Perry+Giles

POSITION SENSORS
Designed to be Better

Lucas NovaSensor®

Leine & Linde



4DE
TECHNOLOGIES

KIPP & ZONEN

CGDEN



**Measurement
Systems**





EXPERIENCE AND SOLUTIONS

AIR MONITOR CORPORATION

- combustion air flow
- drying/quenching air flow
- stack gas flow

BENKE

- distillation analyzers
- freeze, flash and cloud point analyzers
- viscosity analyzers
- NIR spectrometers

DANIEL

- BTU and process gas chromatographs

EG&G BERTHOLD

- non-contact measurement
- level, massflow, basis weight, belt weigher, ash content, sulphur & lead
- microwave moisture
- density

KATES

- flow rate controllers

MAIHAK

- gas analyzers
- thermal conductivity
- total hydrocarbon FID
- TOC
- FTIR

MDA SCIENTIFIC

- toxic substance monitoring
- trace contaminant analysis systems
- single, multipoint, personal
- chemcassette technology

METTLER TOLEDO (INGOLD)

- pH and ORP measurement systems
- dissolved oxygen
- conductivity
- turbidity

PCME

- baghouse monitoring
- particle emission/dust monitors
- opacity/scintillation
- electrodynamic technology

SIEGER

- combustible and toxic gas detection
- infra-red open path hydrocarbon gas detection
- infra-red point gas detection

SOLARTRON

- liquid and gas density
- viscosity: dynamic and kinematic
- defined shear rate viscosity

TA INSTRUMENTS INC

- thermal analysis
- rheology

WEDGEWOOD TECHNOLOGY

- turbidity & colour photometers
- solids concentration
- UV and NIR analyzers
- oil-in-water monitor

WESTECH

- sample systems
- packaged analyzer systems
- CEM's
- detonation flame arresters

WHESOE VAREC

- flame arresters
- tank appurtenances and level gauging systems
- waste gas control equipment
- waste gas burners
- leak detection

	Halifax	Montreal	Toronto	Sarnia	Calgary	Edmonton	Vancouver
Tel:	902-457-1171	514-636-8761	905-890-5265	519-383-6320	403-252-8803	403-464-4740	604-737-8358
Fax:	902-457-1731	514-631-0857	905-890-6213	519-383-6322	403-253-6803	403-467-1605	604-737-8315

e-mail: westech@istar.ca



TELEDYNE FLUID SYSTEMS

Farris Engineering
An Allegheny Teledyne Company

**Manufacturer of Safety-Relief Valves
in Canada for over 30 years.**



**373 S. Vidal St. Unit D-6
Sarnia, Ontario
ph: (519) 332-0141 fax: (519) 332-4939**

NEWS RELEASE

UNITED ELECTRIC

United Electric Controls **new** SPECTRA 12™ Pressure Switch is ideal for operations in explosion proof or harsh environments or where space is at a premium. It can be used in a variety of demanding applications such as on offshore drilling platforms, on pipelines, pumps and compressors.

Further information can be obtained by writing or calling:

In Canada - United Electric Controls Ltd.

5320 Bradco Blvd., Mississauga, Ontario L4W 1G7

Tel: (905) 625-5082 • Fax: (905) 625-5709

New Advertisers

The Annunciator is pleased to announce the following new advertiser:

TRILLIUM Measurement & Control Page 22

Neles-Jamesbury

- Control Valves - Globe & Rotary
- Ball Valves - Soft & Metal Seated
- High Performance Butterfly Valves - Soft & Metal Seated
- Pneumatic & Electric Actuators
- Control Valve Instrumentation

Badger Meter

- Research Control® Valves and Orion® Valves

Burkert

- Solenoid Valves
- Plastic Sensors, Transmitters, Indicators and Controllers

BTG

- Steam Conditioning Valves and Desuperheaters

ExperTune

- PID Loop Analysis and Tuning Software

Hayward

- Polymer Valves, Filters and Strainers

Hoke

- Gyrolok® Tube & Pipe Fittings, Needle Valves

Krohne

- Mass Flowmeters, Magnetic Flowmeters, Rotameters
- Radar-Level Instrumentation

Moore

- XTC™ Smart Transmitters and Transmitter-Controllers
- Single and Multi-Loop Controllers
- Flow and Level Measurement Instrumentation
- Pneumatic Instrumentation

StoneL

- Valve Communication and Monitoring

CASHCO

- PRESSURE REGULATORS
 - Reducing & Back Pressure / Relief
- CONTROL VALVES - Rotary & Linear
- MANUAL LOADERS and AIRSETS

WIKA

- PRESSURE GAUGES - Test, Etc.
- CHEMICAL SEALS
- PRESSURE TRANSMITTERS / TRANSDUCERS

TELEDYNE FARRIS

- SAFETY & RELIEF VALVES
- TANK VENTING
- TEST BENCHES

APICAL

- CHARTS
 - Recording Chart Paper
 - Inking Supplies

TREND

- THERMOMETERS - Bi-metal Gas Actuated

MAGNETROL

- LEVEL CONTROLS - R.F. Capacitance, Ultrasonic & Buoyancy
 - Magnetic Level Indicator
 - Microwave
 - Thermal Dispersion
- FLOW CONTROLS - Vane, Piston Actuated Valve & Thermal Dispersion

PRIBUSIN

- SIGNAL CONDITIONERS
- ALARM UNITS - Indicating

THERMO-KINETICS

- TEMPERATURE - Measurement & Control
- SENSORS - Thermocouples, RTD's, Infrared Thermometers
- THERMOWELLS & PROTECTION TUBES
 - All sizes
- GAYESCO - Refracto-Pads & Flex-O Multicouples

M.T.L.

- INTRINSIC SAFE BARRIERS & INDICATORS



PROVINCIAL CONTROLS

DIVISION OF 660567 ONTARIO LIMITED

P.O. BOX 2946
373 VIDAL ST. S., SARNIA, ONT. N7T 7W2

TELEPHONE: (519) 336-7301
FAX: (519) 336-8082

NUMATICS

- FILTER/REGULATOR/LUBRICATOR
- SOLENOID VALVES - General Purpose, Hazardous, Intrinsically Safe
- AIR CYLINDERS - NFPA, Small Bore, Compact
- ENERTROL - Linear Decelerators, Shock Absorbers
- AIR LOGIC CONTROL
- PANELS - Pneumatic, Electrical & Electronic
- AIR DRYERS - Refrigerated & Regenerative

ERNST

- FLOW AND LEVEL INDICATORS
- SIGHT GLASSES - Glass & Gaskets
- FLOW METERS
- SIGHT FLOW INDICATORS
- EJECTORS & EDUCTORS

ORANGE RESEARCH

- DIFFERENTIAL PRESSURE & FLOW GAUGES

PERMACAL

- PRESSURE GAUGES - Direct Drive
 - Test & Process

CONANT

- SELECTOR VALVES

HANSEN

- QUICK CONNECTS - Pneumatic & Hydraulic

IMPERIAL EASTMAN

- TUBE FITTINGS - Accessories

KINETROL

- ACTUATORS, BRACKETS

P.G.I.

- VALVES & MANIFOLDS

PROVINCIAL INSTRUMENT ENCLOSURES

- FIBERGLASS INSULATED

VORTEC

- VORTEX COOLERS - Pneumatic Transfer / Handling Equipment

DWYER

- DP GAUGES
- SWITCHES
- FLOW METERS

Thermowells & Protection Tubes

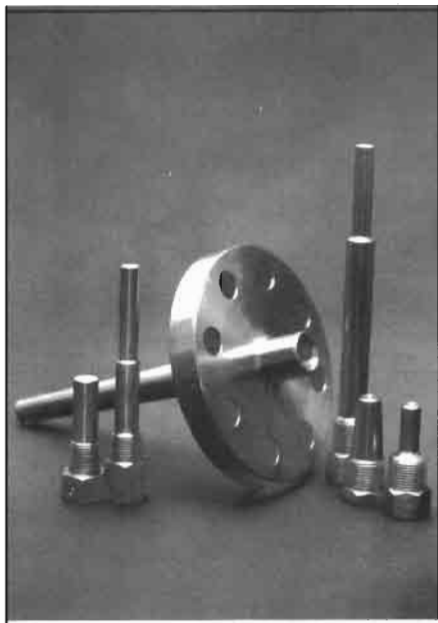

Above shows a small range and type of thermowells

No matter how large or small, one off, rush, exotics material, project or stock, call or fax for courteous prompt attention

Our thermowells are manufactured to accept standard or custom made thermometers, thermocouples, bulbs and RTD's.

Attributes:

- ▼ Solid bore up to 50" long
- ▼ CNC machined, polished finish to assure maximum corrosion resistance.
- ▼ Wide selection threaded, flanged, socket weld, heavy duty tapered for steam lines, vanstone, multicouple units
- ▼ Custom made specials in 24 hours
- ▼ Competitive prices and large in house stock of wells and material

Specifications:

- ▼ Velocity checks upon request to the power test code
- ▼ Manufactured in accordance with ASME, ASTM, ANSI and P.T.C.
- ▼ Canadian registration number
- ▼ Materials A350/LF2 A105 Carbon Steel, 316/L, 304/L, Monel, Alloy 20, Inconel, 446SS, 310SS, 347, 2205, Hastalloy, Titanium, Tantalum Oversheaths
- ▼ ISO 9002 Certified

MAC-WELD

1324 Lougar Avenue,
Sarnia, Ontario
N7S 5N7

1-800-563-0292

Tel: (519) 332-1388

Fax: (519) 332-3280

Distributed by: **YOUR LOCAL SALES
REPRESENTATIVE**

**searchpoint
OPTIMA**

**FIVE YEAR
GUARANTEE**

**SMALLER, LIGHTER, COST EFFECTIVE
SEARCHPOINT OPTIMA TAKES
A FRESH LOOK AT INFRARED FIXED
POINT GAS DETECTION**



The **Searchpoint Optima** is the result of rigorous field testing done under real-life conditions.

The result is a low cost, small, light yet robust point detector that can be retrofitted in existing gas detection systems.

Searchpoint Optima has no moving parts, is easy to maintain, and, with worldwide approvals, satisfies a vast range of applications and environmental conditions.

For the full story, call Westech today!

WHY OPTIMA?

- Can detect a wide range of gases and vapours
- Self Compensating Optics
- Easy gas checking in any environment
- Ideal for retrofits
- Optional Interrogator for one man gas test
- 5 year guarantee



Westech Industrial Ltd. 1004, 1149 Vanier Road, Sarnia, Ontario N7S 3Y6 (519) 383-6320

ANALYTICAL INSTRUMENTATION DRYERS

PUREGAS® HEATLESS AIR DRYERS AND ADSORBERS FOR:

- | | |
|--|--|
| <input type="checkbox"/> Removing H ₂ O and CO ₂ gases | <input type="checkbox"/> Dry gas reference for moisture analyzers |
| <input type="checkbox"/> Dewpoints to -100° F. | <input type="checkbox"/> Dry box purging |
| <input type="checkbox"/> Natural gas drying | <input type="checkbox"/> Prevention of air line freeze-up |
| <input type="checkbox"/> Purging atmosphere chambers | <input type="checkbox"/> Providing dry cooling air for electronic stress testing |
| <input type="checkbox"/> Replacement of nitrogen bottles | <input type="checkbox"/> Explosion proof environments |
| <input type="checkbox"/> Purging infrared spectrophotometers | |

Available as stand alone units with oil free compressors.

For more information call 1-800-787-3547

- Also representing Nicotra SCADA and monitoring systems

canadian puregas equipment limited

P. O. Box 280, Dunnville, Ontario. N1A 2X5

Tel. 905-774 8600 Fax 905-774-6974

- Check boxes and Fax for more information

Start to Finish...Fisher Service is your control valve repair expert.



No other organization offers more expertise in control valve repair than Fisher Service Company.

Fisher Service Company can perform expert valve repairs either in-house or onsite at customer locations.

Call your local Fisher-Rosemount Sales Representative today to find out more.

FISHER SERVICE COMPANY
(519) 332-2300
581 VIDAL ST. S.
SARNIA, ON N7T 2V8



FISHER-ROSEMOUNT



Darryl Annis
Regional Sales Manager

Tel (519) 336-0811
Fax (519) 336-5808
Email bestobell@aims.on.ca

Level Control

- Mobrey
- Madison

Valves

- Tomoe (Butterfly)
- Ashford (Instrument)

Water Quality Analyzers

- Zullig
- KDG Mobrey

Flow Measurement

- Erdco
- Mobrey
- Fox Industries

Steam Traps & Trap Testers

- Bestobell

Temperature Sensing

- Wahl Instruments



Smart Choices from the Leader in Control

For effective measurement and control, choose quality devices from Honeywell's **TotalPlant®** portfolio. They'll help you:

- ✓ Increase productivity and profit
- ✓ Optimize use of raw materials
- ✓ Meet your customers' quality specifications
- ✓ Comply with environmental standards
- ✓ Enhance plant safety

Our **Smartline™** transmitters and flowmeters feature state-of-the-art microprocessor technology for accurate, reliable measurement of temperature, pressure, level and flow. They're field proven, easy to install and configure, and can be digitally integrated to the control system.

Honeywell offers **Leaderline™** controllers, programmers and recorders for almost any industrial application — from simple on-off control to feed forward, cascade and ratio control. Our line of circular and stripchart recorders includes advanced digital models with complex math and communication capabilities.

Superior product performance is built in and backed up by Honeywell's warranty program and comprehensive technical support.

For information, ordering or technical support, call:
Customer Response Centre 1-800-461-0013

Honeywell

Helping You Control Your World

USERS DIRECTORY

This index lists manufacturers and trade-names alphabetically and enables users to determine the local representative for a particular manufacturer or product.

Manufacturer / Tradename

3D
3D
3M
3P
A&M Weston
A.H. Emery
A.S.I.
A.W. Sperry
ABBKent
Accutech
ACL
ACR Systems
Acromag
Action Instruments
Action Instruments
Action Instruments
Action Instruments
Action Instruments
AD Technologies
ADI
Advance Products Spray Shields
AEM Systems
AEMC
AFE Technologies Inc.
Agar
AGI - Atlantic Group Inc.
Aim
Air Flow
Air Monitor Corp.
AiRanger
Aladco Nu-Check Valves
Alltemp Sensors
Alnor Instruments
Altek
Altek
Amalogic
American Reliance
Ametek
Ametek
Ametek - Analyzers
Ametek Gauges
Ametek/Jofra
Amiad
Amot Controls
Amot Controls
Amprobe
AMS
Anderson Greenwood
Aoip
APACS
API Meters
Apical Charts
Apollo
Appalachian Controls
Applied System Technology
ARi
ARi
Armatek
Armstrong
Armtec Industries
ARO
ASCO
ASCO
ASCO
Ascoletric
ASD
Ashcroft
Ashcroft
Ashford Valve
Astro
Athena
Atomac Ball & Check Valves
Aurora
Autotech
Avcom
Avo
AYA

Local Sales Representative

Alpha Controls & Instrumentation
Transcat
Transcat
Romatec
Transcat
Syber Systems Inc.
Westburne Lytle
Transcat
BSP Instruments
Brian Controls
Transcat
Alpha Controls & Instrumentation
Willer Engineering
Cambridge Controls
CTH Industrial Controls
Heaters Controls & Sensors Ltd.
Summit Controls Ltd.
Transcat
Durham Instruments
Cancoppas Limited
Sarnia Piping Specialties
ProSigma Analytics Inc.
Transcat
CTH Industrial Controls
Zirco Ltd.
Controls
Transcat
Transcat
Westech Industrial Ltd.
Milltronics Limited
Provincial Controls
TubeTech Ltd.
Transcat
Alpha Controls & Instrumentation
Transcat
Transcat
Transcat
Brian Controls
Transcat
Westech Industrial Ltd.
Hardie Industrial Services Inc.
Transcat
Flovat Equipment Ltd.
Controls
Great Lakes Industrial Controls
Transcat
Cambridge Controls
Cantech Controls
Omnitronix
Moore Products Co. (Canada) Inc.
Lisle-Matrix Ltd.
Provincial Controls
Romatec
Controls
Transcat
Alpha Controls & Instrumentation
Heaters Controls & Sensors Ltd.
Armatek Controls
Willer Engineering
BEP Bestobell Canada Ltd.
Great Lakes Industrial Controls
Matheson Valves
TubeTech Ltd.
WESCO
Westburne Lytle
Flovat Equipment Ltd.
Brian Controls
Romatec
Transcat
BEP Bestobell Canada Ltd.
ProSigma Analytics Inc.
Transcat
Sarnia Piping Specialties
Great Lakes Industrial Controls
Davis Controls
Transcat
Transcat
Transcat

Manufacturer / Tradename

Azonix
B&K
B.N.W.
B/W Controls
Babbitt
Bacharach
Backos
Badger Meter Inc.
Badger Meter Inc.
Bailey/Fischer & Porter
Balluff
Balston Filters
Barber Colman
Barber Colman
Barksdale
Barnant
Barnant
Barton
Baumann
Beacon Electronics
Beamex
Bebco Industries
Beebe
Beha
BEI - Baldwin Environmental Inc.
BEI - Baldwin Environmental Inc.
Bellofram
Benedict Computer
Benke
Bestobell Steam, Div. of Richards Ind.
Bestobell Valves
Beta
Beta
Beta Calibrators
Biccotest
Biddle
Biddle/Avo
Bi-Lok Fittings
Binmaster
Bin-Master
BJM
BLH Electronics
Bodenseewerk/Perkin Elmer
Boiler-Gard
Bomem
Bourdon-Sedeme (Manobourdon) Gauges
Brandt
Bristol Babcock
Brooklyn Thermometer
Brooks
Brown & Sharpe
Brultech
BS & B
BTG Inc.
BTG Polymetron
Burkert
Burkert
Burkert
BW
Cajon Pipe Fittings
Cal
Calculated Instrumntms
California Analytical
Canadian Meter
Can-Ross
Cantech Systems
Carle Chromatography
Carlo Gavazzi
Carlo Gavazzi-Dupline
Cash-Acme
Cashco Canada, Inc.
Cashco Canada, Inc.
Castell Interlocks
CCS - Custom Control Sensors
Cel Instruments
Cellex
Cellex
Celtek Electronics, Inc.
Cemco
Centre Line
Century Instrument
Cerabar
CEWE
Chandler
Chatam Controls
Checkpoint Systems
Chemelex

Local Sales Representative

Transcat
Transcat
Flovat Equipment Ltd.
Ovantum Sales Inc.
BSP Instruments
Transcat
Great Lakes Industrial Controls
J & M Engineering & Sales Ltd.
Summit Controls Ltd.
TubeTech Ltd.
Davis Controls
Sarnia Piping Specialties
Davis Controls
Ovantum Sales Inc.
TubeTech Ltd.
Heaters Controls & Sensors Ltd.
Transcat
Armatek Controls
Lakeside Process Controls
R.A. Kirby Sales Inc.
Transcat
Cantrols
Transcat
Transcat
Willer Engineering
Romatec
Transcat
Westech Industrial Ltd.
BEP Bestobell Canada Ltd.
BEP Bestobell Canada Ltd.
Armatek Controls
Transcat
Line Process Controls
Transcat
Transcat
Transcat
Sarnia Piping Specialties
Cancoppas Limited
Regional Process Equipment
Transcat
CB Engineering
CEM Specialties Inc.
Lisle-Metrix Ltd.
ProSigma Analytics Inc.
Sarnia Piping Specialties
Willer Engineering
Sharp Valve & Instrumentation
Transcat
Great Lakes Industrial Controls
Transcat
Transcat
Romatec
Summit Controls Ltd.
ProSigma Analytics Inc.
Line Process Controls
Ovantum Sales Inc.
Summit Controls Ltd.
Brian Controls
Huron Valve & Fittings
Davis Controls
Transcat
Brian Controls
BSP Instruments
SPEC (Sarnia) Limited
Cantech Controls
R.A. Kirby Sales Inc.
Heaters Controls & Sensors Ltd.
Davis Controls
Westburne Lytle
Cambridge Controls
Provincial Controls
Great Lakes Industrial Controls
Industrial Projects Ltd.
Transcat
Armatek Controls
SPEC (Sarnia) Limited
Cantrols
Cantech Controls
Matheson Valves
Sarnia Piping Specialties
Endress + Hauser
Cancoppas Limited
Transcat
Heaters Controls & Sensors Ltd.
Cantech Controls
Cantech Controls

Manufacturer / Tradename

Chemical Systems
Chemline
Chemtrol
Chemtrol
Chessell
Clif Mock
CM - Century Valve
Colder
Columbia Scientific
CompuFlo III
Computer Keyboard Systems (CKS)
Conant Controls Inc.
Conant Valves
Conders
Conerstone
Conoflow ITT
Consolidated
Consolidated Controls
Con-Tek
Control Instruments Corp.
Control Microsystems
ControlAir Inc.
ControlAir Inc.
Cooke
Cooper Instruments
Cosa
Cosa
CRL
Crowcon
Crowcon Gas Detection
Crystal
CSI - Microloggers
Cunico
Cutler-Hammer
Cutler-Hammer
Cutler-Hammer IDT
Cybex
Cybex
Dahl
Danaher Controls
Danfoss
Danfoss Mfg. Co. Ltd. - Denmark
Daniel
Daniel Industries
Daniel Industries Canada
Data Industrial Corporation
Data Precision
Datacom Technologies
Datatest
Datatran
Datexel
Davenport
Dekorun Unitherm
Delavan
Delphian
Delta Controls
Delta F Corporation
Deltabar
Delta-M
Deltapilot
Deltavalve
Detector Electronics (Dettronics)
Devar
Devar
DewPro
Dewrance
DeZurik
DGH
DGS - Dover Gas Technologies
Dickson
Digitec
Digitec
Digitron
Dixson
Dixson, Inc.
Dopak
Dow Plastic Lined Piping Products
DPL Plus
Drager
Drainall
Dresser / Heise
Druck
Ducon Environmental Systems
Durabla
Durakool
Dwyer
Dwyer

Local Sales Representative

R.A. Kirby Sales Inc.
Flovial Equipment Ltd.
U & I Supply
WESCO
Willer Engineering
Westburne Lytle
Brian Controls
Davis Controls
R.A. Kirby Sales Inc.
Milltronics Limited
CB Engineering
Industrial Projects Ltd.
Provincial Controls
Transcat
Transcat
Matheson Valves
Contro Valve Inc.
Transcat
Lakeside Process Controls
Willer Engineering
Brian Controls
Cambridge Controls
WESCO
Transcat
Transcat
Brian Controls
Transcat
Cancoppas Limited
Cancoppas Limited
Regional Process Equipment
Transcat
Campbell Scientific (Canada) Corp.
BSP Instruments
Cantech Controls
WESCO
Cantech Controls
CB Engineering
CB Engineering
Armatek Controls
J & M Engineering & Sales Ltd.
Davis Controls
Lisle-Matrix Ltd.
Westech Industrial Ltd.
Controls
Controls
Cambridge Controls
Transcat
Transcat
R.A. Kirby Sales Inc.
Transcat
Transcat
Omnitronix
Great Lakes Industrial Controls
Armatek Controls
Romatec
CTH Industrial Controls
ProSigma Analytics Inc.
Endress + Hauser
Brian Controls
Endress + Hauser
Summit Controls Ltd.
CB Engineering
Cantech Controls
Transcat
Endress + Hauser
Contro Valve Inc.
Flovial Equipment Ltd.
Alpha Controls & Instrumentation
Veronics Inc.
Transcat
Brian Controls
Durham Instruments
Transcat
Transcat
CTH Industrial Controls
Westburne Lytle
Sarnia Piping Specialties
Milltronics Limited
Draeger Canada Ltd.
Great Lakes Industrial Controls
BSP Instruments
Transcat
R.A. Kirby Sales Inc.
Sharp Valve & Instrumentation
Davis Controls
Cantech Controls
Davis Controls

Manufacturer / Tradename

Dwyer
Dwyer
Dwyer DP Gauges/Switches
Dylon
Dynamation
Dynapar
E.G. & G. Chandler
E.I.L. Instruments
Eagle Signal
EAI
Eaton IDT
ECD
EchoMax
Echotel Ultrasonic
EcoFLUX
ECOM America Ltd.
Edgetech
EG & G Berthold
EG & G Flow Technology Inc.
EIT
Elasto-Valve
Elcometer
Eldridge
Eldridge Products
Electromatic
Electromatic
El-O-Matic
Elremco Timers - England
Elsag Bailey
Elsag Bailey Analytical Division
EMCO
Empro Shunts
Enardo
Endress + Hauser
Enertrul Shock Absorbers
Engineered Valves International (E.V.I.)
Enraf Inc.
ENU
Environmental Technologies Group Inc.
EPD Technology
Epic
Erdco
Erhard Valves - Germany
Ernst Flow & Level
ETC
Etcon
Euchner
Eurotherm
Eurotherm
Eurotron
Exact Flow
Exergen
Exotherm
Exper Tune
Expo Safety Systems
Extech
F.B. Leopold - USA
F.W. Bell
F.W. Murphy
Fairchild
Farris
Farris Relief Valves
FCI
Fieldview
Fike
Fike Canada Inc.
Fischer & Porter
Fischer & Porter
Fisher Controls
Fisher Reseach
Fisher Service
Fisher-Rosemount Petroleum
Fisher-Rosemount Systems
Flexibox
Flow & Level Controls
Flow Meter Co. - England
Flowdata Inc.
Flow-Lin
Flowline
Flowseal
Flow-Tek
Fluid Data/Amcor
Fluidic
Fluke
Fox Industries
Foxboro
Foxcroft

Local Sales Representative

Hardie Industrial Services Inc.
Transcat
Provincial Controls
Great Lakes Industrial Controls
Transcat
Davis Controls
R.A. Kirby Sales Inc.
Transcat
Davis Controls
Transcat
Cantech Controls
Novatech
Milltronics Limited
Provincial Controls
Moore Products Co. (Canada) Inc.
R.A. Kirby Sales Inc.
Alpha Controls & Instrumentation
Westech Industrial Ltd.
CB Engineering
Novatech
WESCO
Transcat
Cancoppas Limited
Trillum Measurement and Control
Davis Controls
Heaters Controls & Sensors Ltd.
Westburne Lytle
Lisle-Metrix Ltd.
TubeTech Ltd.
ProSigma Analytics Inc.
Davis Controls
Transcat
Zirco Ltd.
Regional Process Equipment
Provincial Controls
Westburne Lytle
Willer Engineering
Durham Instruments
Novatech
Transcat
Cancoppas Limited
BEP Bestobell Canada Ltd.
Lisle-Metrix Ltd.
Provincial Controls
Transcat
Transcat
Davis Controls
Heaters Controls & Sensors Ltd.
Transcat
BSP Instruments
R.A. Kirby Sales Inc.
Heaters Controls & Sensors Ltd.
Heaters Controls & Sensors Ltd.
Summit Controls Ltd.
Syber Systems Inc.
Transcat
Lisle-Metrix Ltd.
Transcat
Cantech Controls
Line Process Controls
Floval Equipment Ltd.
Provincial Controls
Willer Engineering
Lakeside Process Controls
Sharp Valve & Instrumentation
Brian Controls
Elsag Bailey
TubeTech Ltd.
Lakeside Process Control
Transcat
Lakeside Process Controls
Trillum Measurement and Control
Lakeside Process Controls
U & I Supply
Trillum Measurement and Control
Lisle-Metrix Ltd.
J & M Engineering & Sales Ltd.
BSP Instruments
Davis Controls
Matheson Valves
Summit Controls Ltd.
Armatek Controls
CB Engineering
Transcat
BEP Bestobell Canada Ltd.
SPEC (Sarnia) Limited
Cancoppas Limited

Manufacturer / Tradename

FPP
Frontline
Fuji
Fuji Electric
Fuji Electric
Fujikin of America Inc.
Fulier
Furon
Furon
Fuzypro
G. H. Flow
G.L. Stebbins Co.
G. W. Dahl
Galtek
Gamma Silometer
Gasco Gas Analysis Systems Company, Inc.
Gastech
Gastech Instruments
Gems Sensors
Gemu
General Eastern
General Radio
General Resistance
Geokon
George Fischer +GF+
GGOSCO Needle Valves
GGOSCO Valves
GH Flow Automation
Gitta Proximity Sensors
Global
GO Regulators
GO Switch (Proximity)
GP:50
GPE
GPI
Graham Manufacturing
Gralab
Granucor
Granulflow
Granumet
Graseby / STI
Great Plains Industries
Greyline Instruments, Inc.
Griswold Separators
Gulf Valve
Gyrolok
H.D. Baumann
Hach
Hancock
Hanna
Hansen Quik Connects
Hardy Instruments
Hart Scientific
Hart Scientific
Hartman & Braun
Hartman-Technica
Harwil Corp.
Hathaway
Hathaway / Beta
Haven
Haws
Hayward
Hayward
HCS
HD Electric Company
Hecon
Hedland
Hedland Flowmeters
Heise
Heise
Hersey Flow Measurement
Hewlett Packard
Hex Valve
Hiltap Couplers
Hiltroft
Hitachi
Hoffer Flow Controls - USA
Hoke
Honeywell
Honeywell - Controllers & Recorders
Honeywell - Instruments
Honeywell - Instruments
Honeywell - Recorders
Houston Atlas
Huntron
Hyberlab
Hycal

Local Sales Representative

Cancoppas Limited
Transcat
Heaters Controls & Sensors Ltd.
Transcat
WESCO
Ovantum Sales Inc.
Syber Systems Inc.
Great Lakes Industrial Controls
Intertec
Heaters Controls & Sensors Ltd.
Cantech Controls
BSP Instruments
Armatek Controls
Romatec
Endress + Hauser
Novatech
Transcat
R.A. Kirby Sales Inc.
IMO Industries
Matheson Valves
Willer Engineering
Transcat
Transcat
Campbell Scientific (Canada) Corp.
Brian Controls
Westburne Lytle
Hardie Industrial Services Inc.
Ovantum Sales Inc.
Heaters Controls & Sensors Ltd.
Transcat
Sarnia Piping Specialties
Lakeside Process Control
Omnitronix
Sharp Valve & Instrumentation
Transcat
Lakeside Process Controls
Transcat
Endress + Hauser
Endress + Hauser
Endress + Hauser
CB Engineering
Armatek Controls
Controls
Flovat Equipment Ltd.
Cantech Controls
Summit Controls Ltd.
Lakeside Process Controls
Fryston Canada Inc.
Contro Valve Inc.
Transcat
Provincial Controls
CTH Industrial Controls
Alpha Controls & Instrumentation
Transcat
TubeTech Ltd.
Transcat
Ovantum Sales Inc.
Line Process Controls
Transcat
Cancoppas Limited
Great Lakes Industrial Controls
CTH Industrial Controls
Summit Controls Ltd.
Great Lakes Industrial Controls
Transcat
Transcat
Brian Controls
R.A. Kirby Sales Inc.
BSP Instruments
Transcat
Flovat Equipment Ltd.
Transcat
Sharp Valve & Instrumentation
U & I Supply
Syber Systems Inc.
Transcat
Lisle-Metrix Ltd.
Summit Controls Ltd.
Davis Controls
Provincial Controls
Brian Controls
Flovat Equipment Ltd.
Transcat
R.A. Kirby Sales Inc.
Transcat
Transcat
Davis Controls

Manufacturer / Tradename

HydroGuard
Hytork
IBM Industrial Computers
ICC Federated
Ice
ICI
IET Labs
IMI Cash Valve
Imperial Eastman Fittings
Imperial Eastman Fittings
IMS
Industrial Control
Industrial Scientific
Industrial Sensors
Industrial Tech. Services
Ingredient Masters
Innovative Sensors Inc.
Inor
Instek America
Intellution
Intempco Controls Ltd.
Intempco Controls Ltd.
Interface
Interface
International Data Sciences
International Instruments
International Sensor Technology
Ion Track Instrumentation (ITI)
Ionics Instrument Division
Iotron
Iron
ISI
Isolok
Isotek
ITT Barton Instruments
ITT Conoflow Transducers & Regulators
ITT Engineered Valves
ITT Neo-Dyn Pressure Switches
ITT Pomona
IVO Industries - USA
J.M. Canty, Inc.
Jacoby Tarbox
Jerguson Level Gauges
Jewell
Jofra
Johnson Yokogawa
Jordan Controls, Inc.
J-Tec
Julius Bauser - Germany
JUM
Kammer Valves
Kane-May
Kates
Kavlico
Kay Ray / Sensall
Kaye
Kaye Instruments
KDG Mobrey
Keddco Mfg. Ltd.
Keller
Kenmac
Kent Meters
Kenwood USA
Kep
Kep
Ketema
Keystone
KF Industries
Kinetrol Actuators
Kinetrol Actuators
King Instrument Company
King Valves
Kipp & Zonen
Kipp & Zonen
Kistler-Mores
Kitz
KL Flow
Klinger
Klinger
KNF Neuberger
Kobold
Kobold
Kobold
Koch
Komax Heaters
Kotron Capacitance
Kreyenborg

Local Sales Representative

Endress + Hauser
Matheson Valves
CB Engineering
Transcat
Transcat
Cancoppas Limited
Transcat
BSP Instruments
Provincial Controls
U & I Supply
Great Lakes Industrial Controls
Transcat
Brian Controls
Heaters Controls & Sensors Ltd.
BSP Instruments
Ovantum Sales Inc.
ProSigma Analytics Inc.
Alpha Controls & Instrumentation
Transcat
CB Engineering
Cantech Controls
Matheson Valves
Durham Instruments
Willer Engineering
Transcat
Transcat
Industrial Projects Ltd.
BEP Bestobell Canada Ltd.
Veronics Inc.
WESCO
Willer Engineering
Heaters Controls & Sensors Ltd.
Great Lakes Industrial Controls
Transcat
Armatec Controls
Sarnia Piping Specialties
Romatec
Sarnia Piping Specialties
Transcat
Lisle-Metrix Ltd.
Cambridge Controls
Romatec
Romatec
Transcat
Transcat
CB Engineering
Cambridge Controls
Brian Controls
Lisle-Metrix Ltd.
BSP Instruments
Matheson Valves
Transcat
Westech Industrial Ltd.
Davis Controls
Rosemount Instruments
Transcat
CB Engineering
BEP Bestobell Canada Ltd.
U & I Supply
Campbell Scientific (Canada) Corp.
Great Lakes Industrial Controls
BSP Instruments
Transcat
Brian Controls
Transcat
Brian Controls
Cantech Controls
Great Lakes Industrial Controls
Hardie Industrial Services Inc.
Provincial Controls
Industrial Projects Ltd.
Zirco Ltd.
Durham Instruments
Transcat
Ovantum Sales Inc.
Matheson Valves
Cancoppas Limited
Davis Controls
SPEC (Sarnia) Limited
Transcat
Cancoppas Limited
Regional Process Equipment
Transcat
Romatec
Sharp Valve & Instrumentation
Provincial Controls
Great Lakes Industrial Controls

Manufacturer / Tradename

Krohne
Krohne
K-Sun
K-Tek
KTM Ball Valves
Kuebler Control Eng.
Kurz
Kurz
Kyoritsu
Kyowa
L & J Technologies
L.J. Star Inc.
LAGCO Flumes - USA
Land
Larad
Laurel Electronics
Laurence
LC Meters
LCI-Luwa
Leader
Leaderline
Lee-Dickens Ltd. - England
Leica
Leine & Linde
Lem
LEOPOLD
Leslie
LFE API Instruments
LFE Instruments - USA
LI-COR
Limitorque
Linatex
Liquid-O-Ring
Liquiphant
Lloyd
LMI
LMI
Logic Beach
Logic Bench
Lucas Novasensor
Ludlow-Renssealer
Lufran
Lumenite Electronic Company
M & C Products
M point
M&G Check Valves
M. System
M.T.L.
M.T.S.
MA - Molecular Analytics LLC
Macro Sensors
MacWeld
Madison
Madison Co.
Madur Electronics
Magnetrol
Magnetrol Level & Flow
Maihak
Manobourdon Pressure Gauges
Marine Moisture Co.
Martel Electriconics
Masonellan
Massa
Master Appliance
Max
McCrometer
MCS
MDA Scientific
MDI
Measurement Systems
Meeco Inc.
Mensor
Mercoïd
Meriam Instruments
Meriam
Mesa Laboratories
Met One
Metratek
Metrix
Metrix Timers
Metrohm
Mettler Toledo (Ingold)
Micon
Micro Motion
Micro Wire Products
Micropilot
MicroRanger

Local Sales Representative

Moore Products Co. (Canada) Inc.
Summit Controls Ltd.
Transcat
CB Engineering
Regional Process Equipment
Ovantum Sales Inc.
Brian Controls
Transcat
Omnitronix
Omnitronix
Line Process Controls
J & M Engineering & Sales Ltd.
Lisle-Metrix Ltd.
Transcat
Syber Systems Inc.
Transcat
Great Lakes Industrial Controls
SPEC (Sarnia) Limited
Great Lakes Industrial Controls
Transcat
Honeywell
Lisle-Metrix Ltd.
Transcat
Durham Instruments
Transcat
Lisle-Metrix Ltd.
Great Lakes Industrial Controls
Transcat
Lisle-Metrix Ltd.
Campbell Scientific (Canada) Corp.
Sharp Valve & Instrumentation
Flovat Equipment Ltd.
Great Lakes Industrial Controls
Endress + Hauser
Omnitronix
Novatech
U & I Supply
Durham Instruments
Transcat
Durham Instruments
Sharp Valve & Instrumentation
Heaters Controls & Sensors Ltd.
J & M Engineering & Sales Ltd.
CEM Specialties Inc.
Endress + Hauser
Matheson Valves
Alpha Controls & Instrumentation
Provincial Controls
R.A. Kirby Sales Inc.
Novatech
Durham Instruments
Heaters Controls & Sensors Ltd.
BEP Bestobell Canada Ltd.
Ovantum Sales Inc.
Novatech
Flovat Equipment Ltd.
Provincial Controls
Westech Industrial Ltd.
Sarnia Piping Specialties
R.A. Kirby Sales Inc.
Transcat
Contro Valve Inc.
Durham Instruments
Transcat
Willer Engineering
Brian Controls
Heaters Controls & Sensors Ltd.
Westech Industrial Ltd.
Heaters Controls & Sensors Ltd.
Durham Instruments
Novatech
Transcat
Davis Controls
Brian Controls
Transcat
Armatek Controls
Campbell Scientific (Canada) Corp.
Transcat
Transcat
Lisle-Metrix Ltd.
Transcat
Westech Industrial Ltd.
Cantech Controls
Rosemount Instruments
SPEC (Sarnia) Limited
Endress + Hauser
Milltronics Limited

Manufacturer / Tradename

Mid-West Instrument
Mid-West Instrument
Mihjets
Mihproducts Division
Mikron
Mikron
MillFlo
Milltronics
Milton Roy - Liquid Metronics Division
Milwaukee
MiniRanger Plus
Mini-X Purge Systems
Mini-Z Purge Systems
Mitac
Mitsubishi
Mitutoyo
MKS
Mobrey
Modutec
Monarch
Monitek
Monitor Labs
Monitor Labs
Moore
Moore
Moore Industries
Moore Products
M-Tek
MTL
MTL Intrinsic Safe Barriers
Mueller
Multicap
Multiglass
MultiRanger Plus
Mycro
Myron L
Nassau Instrument
National Meter
NBS
NDT International
Neilsen-Kuljian
Neles-Jamesbury
NemaSoft
Neotronics
NICE
Nilcor
Nivocompact
Nivosonic
Norriseal Butterfly Valves
Norstat
Northern Vibrator
Noshok
Novatech Engineering Group
Numatics Cylinders
Numatics F/R/Ls
Numatics Solenoid Valves
Nupro Valves
Nusonics
Oakton
O'Brien Corporation
OCM III
Ogden
Ogden
Ogontz
Ohmart Vega
Oil Gear
Oilgear
Oldham
Olin Instruments
Oliver Valves
Optek
Optex
Optima
Opto 22
Orange Research DP Switch
Orbe Knife Gates Valves
Orion
OSI Semitronic
Pace
Pacer Industries
Pamark Manifolds
Panalarm
Panalarm
Panametrics PCI Division
Papailias
Parker Fluid Connectors
Partlow

Local Sales Representative

Brian Controls
Hardie Industrial Services Inc.
SPEC (Sarnia) Limited
SPEC (Sarnia) Limited
Armatek Controls
Transcat
Milltronics Limited
Milltronics Limited
U & I Supply
Flovac Equipment Ltd.
Milltronics Limited
Syber Systems Inc.
Syber Systems Inc.
CTH Industrial Controls
Davis Controls
Transcat
Transcat
BEP Bestobell Canada Ltd.
Transcat
Transcat
Willer Engineering
Brian Controls
Romatec
Moore Products Co. (Canada) Inc.
Summit Controls Ltd.
Armatek Controls
Transcat
Transcat
Syber Systems Inc.
Provincial Controls
Great Lakes Industrial Controls
Endress + Hauser
Great Lakes Industrial Controls
Milltronics Limited
Moore Products Co. (Canada) Inc.
Transcat
Transcat
Transcat
Transcat
Transcat
Summit Controls Ltd.
Davis Controls
Cantech Controls
Cancoppas Limited
Contro Valve Inc.
Endress + Hauser
Endress + Hauser
Sarnia Piping Specialties
Davis Controls
Flovac Equipment Ltd.
IMO Industries
Novatech
Provincial Controls
Provincial Controls
Provincial Controls
Huron Valve & Fittings
Armatek Controls
Transcat
CB Engineering
Milltronics Limited
Durham Instruments
Heaters Controls & Sensors Ltd.
Cantech Controls
TubeTech Ltd.
Armatek Controls
BEP Bestobell Canada Ltd.
Cantech Controls
Veronics Inc.
Sarnia Piping Specialties
R.A. Kirby Sales Inc.
Heaters Controls & Sensors Ltd.
Westech Industrial Ltd.
CB Engineering
Provincial Controls
Regional Process Equipment
Transcat
CTH Industrial Controls
Transcat
Transcat
Provincial Controls
Cambridge Controls
Willer Engineering
Veronics Inc.
Great Lakes Industrial Controls
TubeTech Ltd.
WESCO

Manufacturer / Tradename

Patriot
Paul Mueller
PCME
Pelican
Penberthy Instruments
Penberthy, Inc.
Penny + Giles
Penny + Giles
Pepperl + Fuchs - USA
Perma-cal Gauges
Perma-Pure
PGI
PGI Valves & Manifolds
Phase Dynamics
Phipps & Bird
Pick Heaters
PMV
PMV
Polymetron
Porter Instrument Co. - USA
Powers
Powers Process Controls
Powers Process Controls
Powertronics
Precision Digital Corp.
Precision Digital Corp.
Precision Digital Corp.
Precision Digital Corp.
Precision Digital Corp.
Preso Meters Corp.
Preso Meters Corp.
Pribusin Inc.
Pribusin Inc.
Progressive Electronics
Prolevel
Promac
Promag
Promag
Promass
Proquip
Prosonic
Proteck
Provincial Instrument Enclosures
Provox
Prowirl
Proximity Controls
Pulsafeeder
Puriflucs
Pyromation, Inc.
QSDM
QSDM
Quadtech (Gen Rad)
Quality Control Equip.
R.M. Young
R.P. Adams
Radiant Heat
Ralston
Ralston
Ramsey Canada
Raychem
Raychem / Chemelex
Raytek
Raytek
Raytek
Raytek
Raytek
Raytek / UE
RC Systems
RdF
RdF
REBS
Regal
REK RKC
Reotemp
Research Control Valves
Resistoflex
Rexroth
Rezplast
RGS
RIMCO - Raingauges
RKC
Roberts Mfg.
Robertshaw
Rochester
Rochester Instrument Systems
Rohrback Cosasco Systems

Local Sales Representative

Durham Instruments
Great Lakes Industrial Controls
Westech Industrial Ltd.
Transcat
Hardie Industrial Services Inc.
Brian Controls
Cantech Controls
Durham Instruments
Lisle-Matrix Ltd.
Provincial Controls
Great Lakes Industrial Controls
Regional Process Equipment
Provincial Controls
Armatek Controls
Transcat
Sharp Valve & Instrumentation
Cancoppas Limited
Regional Process Equipment
ProSigma Analytics Inc.
Lisle-Matrix Ltd.
Line Process Controls
CTH Industrial Controls
Heaters Controls & Sensors Ltd.
Transcat
Alpha Controls & Instrumentation
Armatek Controls
Cambridge Controls
CTH Industrial Controls
Ovantum Sales Inc.
R.A. Kirby Sales Inc.
Floval Equipment Ltd.
Willer Engineering
Novatech
Provincial Controls
Transcat
Endress + Hauser
Line Process Controls
Endress + Hauser
Westburne Lytle
Endress + Hauser
SPEC (Sarnia) Limited
Endress + Hauser
BSP Instruments
Provincial Controls
Lakeside Process Control
Endress + Hauser
BEP Bestobell Canada Ltd.
Romatec
Great Lakes Industrial Controls
WESCO
Alpha Controls & Instrumentation
Willer Engineering
Transcat
Ovantum Sales Inc.
Campbell Scientific (Canada) Corp.
Great Lakes Industrial Controls
Heaters Controls & Sensors Ltd.
Heaters Controls & Sensors Ltd.
Transcat
Ovantum Sales Inc.
Great Lakes Industrial Controls
Cantech Controls
Alpha Controls & Instrumentation
CTH Industrial Controls
Heaters Controls & Sensors Ltd.
Transcat
WESCO
Great Lakes Industrial Controls
Cancoppas Limited
Transcat
Willer Engineering
Campbell Scientific (Canada) Corp.
Cancoppas Limited
Heaters Controls & Sensors Ltd.
Cantech Controls
Lakeside Process Control
Sharp Valve & Instrumentation
Great Lakes Industrial Controls
Great Lakes Industrial Controls
Syber Systems Inc.
Campbell Scientific (Canada) Corp.
Heaters Controls & Sensors Ltd.
BSP Instruments
Line Process Controls
Transcat
Sharp Valve & Instrumentation
Armatek Controls

Manufacturer / Tradename

Ronan
Roper Pump
Rosemount
Rosemount Analytical
Rosemount Analytical
Rosemount Combustion Control
Rosemount RS3 Systems
Rotek
Rotronic
Rotronic
Rotronic Instruments
Royce
RTP
Ruffneck Heaters
Rupture Pin Technology
Ruskin
Rustrack
Rustrak
S.P.S. Instrument Services
Saab
Saab Tank Radar Level
Samson
Samson
Schaevitz
Schlumberger/Neptune Flow Meters
Schonsted
Scientific Linings & Coatings
Sealed Unit Parts
Seametrics Inc.
SeaMetrics Inc.
Seepax
Selco / Asahi
Selco / Asahi
Senaco Plus
Senior Flexionics
Sensall
Sensit
Sensit
Sensorex
Sensorlink
Sensortech Systems Inc.
Sensörtronics
Sensotec
Sensycon
Sensycon
Sentry
Serge-Baril
Servomex
Setra
Sfere
Sfere
Shamrock Environmental
Shan Rod Inc.
Shand & Jurs
Shimpo
Showa
Sieger
Siemens Process Analyzers
Sierra Monitor
Signet Scientific
Sigrist-Photometer Co. - Switzerland
Silometer
Simpson
Sinclair Collins
Skinner
Smar
Smartline
SMC Knifegate
Sno-Trik
Solartron
Solent & Pratt
Soliphant
Solomat
SOR Inc.
South-West Meters
Southwest Valve
Sparling
SPL Plus
SPM
SPS Fibre Form Enclosures
SSI
SSI Equipment
SSI Strainers
Stahl
Statham Transmitters
Stewart Instruments
StoneL

Local Sales Representative

Industrial Projects Ltd.
U & I Supply
Rosemount Instruments
Rosemount Instruments
Trancat
Romatec
Lakeside Process Control
Trancat
Alpha Controls & Instrumentation
Durham Instruments
Trancat
Cancoppas Limited
Davis Controls
Great Lakes Industrial Controls
Zirco Ltd.
BSP Instruments
Trancat
Omnitronix
Sarnia Piping Specialties
Brian Controls
R.A. Kirby Sales Inc.
Ovantum Sales Inc.
Samson Controls
Durham Instruments
Sarnia Piping Specialties
Trancat
Cantech Controls
Trancat
Line Process Controls
Veronics Inc.
U & I Supply
CTH Industrial Controls
Trancat
Milltronics Limited
Regional Process Equipment
Alpha Controls & Instrumentation
Durham Instruments
Durham Instruments
Durham Instruments
Trancat
Trancat
Novatech
Durham Instruments
Line Process Controls
Elsag Bailey
TubeTech Ltd.
Fryston Canada Inc.
Great Lakes Industrial Controls
Novatech
Alpha Controls & Instrumentation
Cancoppas Limited
Regional Process Equipment
ProSigma Analytics Inc.
Flovat Equipment Ltd.
Line Process Controls
Trancat
Durham Instruments
Westech Industrial Ltd.
Willer Engineering
Trancat
Hardie Industrial Services Inc.
Lisle-Matrix Ltd.
Endress + Hauser
Trancat
Summit Controls Ltd.
Cantech Controls
BSP Instruments
Honeywell
Matheson Valves
Huron Valve & Fittings
Westech Industrial Ltd.
BSP Instruments
Endress + Hauser
Trancat
Durham Instruments
Sarnia Piping Specialties
Flovat Equipment Ltd.
Brian Controls
Milltronics Limited
Trancat
Sarnia Piping Specialties
Great Lakes Industrial Controls
Flovat Equipment Ltd.
Matheson Valves
Alpha Controls & Instrumentation
Sarnia Piping Specialties
Flovat Equipment Ltd.
Regional Process Equipment

Manufacturer / Tradename

StoneL
Storage Battery Systems
Strahman
Superior
Swagelok Tube Fittings
Syscon
Systematix
TA Instruments, Inc.
Tapecoat Canada
Tate-Andale
Taylor
TBI-Bailey
TBI-Bailey
TBV
TDC-3000
Tech Spray
Techine
Techmation
Technipower
Technova
Technova
Tektronix
Tektronix
Teledyne
Teledyne Analytical
Teledyne-Farris Relief Valves
Telegan
Telematic
Tel-Tru
Tel-Tru
Tel-Tru Thermometers
Tempco
Tenor Industrial Control
Test Probes
Texas Electronics - Raingauges
Texas Sampling
Texas Sampling Inc.
TFL - Torbar Flowmeters Ltd.
The Electron Machine Corporation
The Probe
Theben
Thermal Instrument Co.
Thermax
Thermo Electric
Thermo Electric
Thermo-Kinetics Temperature Products
Thermon
Thermox
TIF
Time Electronics
TN Technologies
Tomoe Valves
Tong Yung Valves
Tower-Gard
Trademark Mfg.
Transcat
Transmation
Transmation, Inc.
Transmation, Inc.
Transtector Systems
TRC
Trend B-Metal Thermometers
Trerice
Tricentric
Tripplett
Tripp-Lite
Tritron
Trueline Valves
TSI
Tuffline Valve
Turbo
TVL
Tytronics Inc.
U.S. Gauge (Ametek)
UE - United Electric
United Electric
United Electric Controls (Canada) Ltd.
United Sciences Inc.
Unitherm
Unitherm
Universal
Universal Analyzers
Universal Flow Monitors
Unomat
Uvicor
V.R.C. Positioners
Vaccon Vacuum Products

Local Sales Representative

Summit Controls Ltd.
Transcat
Cantech Controls
Great Lakes Industrial Controls
Huron Valve & Fittings
Heaters Controls & Sensors Ltd.
Willer Engineering
Westech Industrial Ltd.
Sarnia Piping Specialties
Great Lakes Industrial Controls
Transcat
Elsag Bailey
TubeTech Ltd.
Romatec
Honeywell
Transcat
Transcat
Lakeside Process Control
Transcat
Matheson Valves
Matheson Valves
Omnitronix
Transcat
Transcat
Armatek Controls
Provincial Controls
BEP Bestobell Canada Ltd.
Willer Engineering
Brian Controls
Transcat
Hardie Industrial Services Inc.
Heaters Controls & Sensors Ltd.
Heaters Controls & Sensors Ltd.
Transcat
Campbell Scientific (Canada) Corp.
Great Lakes Industrial Controls
BEP Bestobell Canada Ltd.
Industrial Projects Ltd.
Industrial Projects Ltd.
Milltronics Limited
Davis Controls
R.A. Kirby Sales Inc.
Transcat
Armatek Controls
Transcat
Provincial Controls
SPEC (Sarnia) Limited
Willer Engineering
Transcat
Transcat
Romatec
BEP Bestobell Canada Ltd.
Regional Process Equipment
Lisle-Metrix Ltd.
BSP Instruments
Transcat
Alpha Controls & Instrumentation
Controls
Transcat
Cantech Controls
Transcat
Provincial Controls
Great Lakes Industrial Controls
Westburne Lytle
Transcat
Transcat
Great Lakes Industrial Controls
Line Process Controls
Willer Engineering
Regional Process Equipment
WESCO
U & I Supply
Novatech
Transcat
Brian Controls
Regional Process Equipment
Cambridge Controls
Willer Engineering
Great Lakes Industrial Controls
Intertec
Alpha Controls & Instrumentation
Willer Engineering
Transcat
Transcat
Davis Controls
Matheson Valves
Provincial Controls

Manufacturer / Tradename

Vaisala
Vaisala - RH, Barometric Pressure
Valhalla
Valdyne
Valtek Controls Ltd.
Valve Concepts
Valvetechnologies Inc.
Vector-VID
Veeder-Root
Velan
Versatile Instruments
Viatran
Vista Scientific
Vitec
Vogt Valve
Vortec Coolers
Vortisand
Wabco
Wahl Instruments
Walker Scientific
Wallace & Tiernan Inc.
Wallace & Tiernan Inc.
Warren Jones Engineering - England
Warrick
Waterman Industries - USA
Watson, McDaniel
Watts Industries
Watts Industries
Wavetek
Wedgewood Technology
Weed
Wedgewood Technology
Weidmuller - Conditioners/Power Supplies
Weschler Instruments
West
Westcon
Westech
Westinghouse
Westlock
Westronics
Wey Valve
Whesso Varec
Whipps Inc. - USA
Whitey Valves
Whitman
Wika
Wika
Wika Chemical Seals
Wika Gauges
Wika Instruments Canada
Wika Pressure Transmitters/Transducers
Wilerson Instrument Co. Inc.
Williams Instrument Co.
Winters
Wizom Cobtrols, Inc.
Wodex Power Transducers
Wood
Wood's
Worcester
Worcester Controls
Wright-Austin
WSA
Xomox Tufline
XPL Plus
Xytronic
Yarway
Yokogawa
Yokogawa
Zellweger Analytics
Zirtek Corporation
Zullig

Local Sales Representative

Transcat
Campbell Scientific (Canada) Corp.
Transcat
Cancoppas Limited
Matheson Valves
Zirco Ltd.
Regional Process Equipment
Transcat
Davis Controls
Westburne Lytle
Sharp Valve & Instrumentation
Willer Engineering
Transcat
Transcat
Matheson Valves
Provincial Controls
Great Lakes Industrial Controls
Great Lakes Industrial Controls
BEP Bestobell Canada Ltd.
Transcat
J & M Engineering & Sales Ltd.
Transcat
Lisle-Matrix Ltd.
Davis Controls
Lisle-Matrix Ltd.
BSP Instruments
Flovat Equipment Ltd.
Great Lakes Industrial Controls
Transcat
Zirco Ltd.
Cantech Controls
Westech Industrial Ltd.
CTH Industrial Controls
Transcat
Omnitronix
Transcat
Westech Industrial Ltd.
WESCO
Matheson Valves
Durham Instruments
Great Lakes Industrial Controls
Westech Industrial Ltd.
Lisle-Matrix Ltd.
Huron Valve & Fittings
Davis Controls
Hardie Industrial Services Inc.
Sharp Valve & Instrumentation
Provincial Controls
Provincial Controls
Regional Process Equipment
Provincial Controls
J & M Engineering & Sales Ltd.
Willer Engineering
Flovat Equipment Ltd.
CB Engineering
Line Process Controls
Cantech Controls
U & I Supply
Flovat Equipment Ltd.
U & I Supply
Great Lakes Industrial Controls
Great Lakes Industrial Controls
Regional Process Equipment
Milltronics Limited
Transcat
Great Lakes Industrial Controls
CB Engineering
Transcat
ProSigma Analytics Inc.
R.A. Kirby Sales Inc.
BEP Bestobell Canada Ltd.



Swagelok® SUPPORT SYSTEM

for tubing and pipe

The SWAGELOK Support System

- enhances system reliability.
- absorbs shock and vibration.
- makes system easily accessible for installation and maintenance.
- reduces stress on system components.
- resists most chemicals and corrosives.
- is manufactured from a non oxidizing material.
- prevents electrical conductivity between system and supports.
- resists ultra-violet light.
- resists compression set.

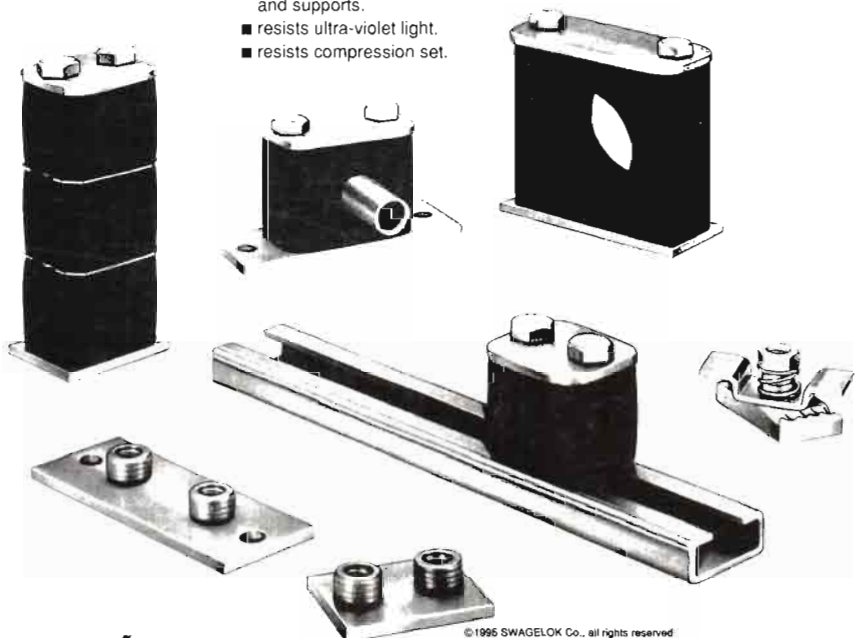

**HURON
VALVE FITTING
LIMITED**

1-800-265-7575
336-3453

800 Confederation St
P.O. BOX 386
SARNIA, ONT. N7T 7J2

©1996 SWAGELOK Co., all rights reserved

Swagelok
HOSE PRODUCTS



SWAGELOK Quick-Connect Co.
Hudson, Ohio 44236 U.S.A.

Proud To Serve You Locally



1907 - 1997

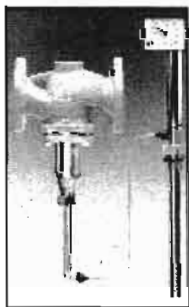

Control Valves

Actuators

Valve Accessories

Steam Conditioning Systems

Process Instrumentation

Self Operated Regulators

Valve Repair Centre

24 HR DELIVERY AND SERVICE

SAMSON CONTROLS INC.

TOLL FREE 1-800-7-SAMSON

(1-800-772-6766)

Tel: (519) 464-6018

Fax: (519) 246-1460



You Can Depend On Us

1907 - 1997

LAKESIDE

FISHER

FISHER CONTROLS INTERNATIONAL, INC.

Control valves - Globe and rotary

Noise and cavitation reduction control valves

Actuators and positioners - pneumatic, electric electro-hydraulic

REGULATORS - Steam, gas and liquids - tank blanketing

Process Instrumentation:

- Electronic and pneumatic controllers
- FIELDVUE™ - digital valve controllers

FISHER SERVICE

- Valve repairs, factory and site
- Maintenance and shut-down management
- Diagnostics for pneumatically operated valves
- Start-up assistance
- Asset Management Service

CON-TEK

- Steam Conditioning Valves and Desuperheaters

H.D. BAUMANN

- Control Valves and Control Equipment
- General purpose control valves
- Corrosion resistant valves
- Low flow control valves

FISHER-ROSEMOUNT

FISHER-ROSEMOUNT SYSTEMS INC.

PROVOX distributed control systems and Rosemount System 3™

- Service:**
- Engineering and project management
 - Installation and start-up assistance
 - System life management

DeltaV

- Scalable process system for small process control applications



GO
SWITCH

GENERAL EQUIPMENT & MANUFACTURING COMPANY INC.

- Proximity limit switches

ISO 9001



Lakeside Process Controls Ltd.

581 Vidal Street South, Sarnia, Ontario, N7T 2V8

Phone: (519) 332-2300 Fax: (519) 332-6640

"Superior Service Supporting You"