

ANNUNCIATOR

JULY 1997



SARNIA



SECTION

The International Society
for Measurement and Control





GREAT LAKES (Division of MENTEC) INDUSTRIAL CONTROLS®

Phone: (519) 336-9512

Fax: (519) 336-9834



BROOKS ... LOOP-POWERED Oval-Gear Flow Meters For High Viscosity Low Pressure Drop Applications, Rotameters, Purge-Meters, Massflow Meters & Controllers For Liquids & Gases



..... Severe Service Control Valves With Class 8 Shut-Off, Optical Laser-Beam Valve Positioning Systems, Controllers, Instantaneous Steam-Water Heaters, Steam-Water Mixers, Non-Fouling Gas & Steam Regulators, K-MAX Rotary Control Valves, Emergency Process Shut-Off Valves



PERMA PURE

... Nafion-Tube Process Gas Dryers For Analysers & High Volume Mainstream Applications, Custom Gas-Sample Conditioning Systems For CEMS Applications, Small Flow Self-Regenerating Heatless Air Dryers, Dew Points To -45°C



RUFFNECK Heaters

... Steam & Glycol Unit Heaters, Ex-Proof Electric Unit Heaters, Ex-Proof Thermostats



SUPERIOR FLO PRODUCTS

.... FLO-TUBE Multi-Port Averaging-Type Flow Sensors For Steam, Gas & Liquids, Hot-Tap Designs, Temp. & Pr. Ratings To 3,000°F / 5,000 psig



TEXAS SAMPLING

..... Custom Closed-Loop Sampling Systems For Liquids & Gases, Emission-Free Design With Zero Dead-Volume Sampling, Manual & Automatic Operation

Tretrice

..... Pressure-Gauges & Diaphragm Seals, Thermometers, Fail-Safe Temperature Regulators, Automatic Steam Tracing Control Valves To Prevent Instrument Enclosures From Overheating



..... High-Performance Ball & Butterfly Valves, API & EXXON Firesafe Approved, Pneumatic & Electric Actuators, Anti-Fugitive Emission Valves

YARWAY

..... Steam Traps & Strainers & Expansion Joints

1387 Confederation St., Sarnia, Ontario N7S 5P1

List of Advertisers

Company	Page No.	Company	Page No.
ABB-Kent Taylor	17	Lakeside Process Controls	80
Alpha Controls	39	Langtree Controls Ltd.	17
Armatek Controls	15	Line Process Controls	50
Associated Valve Corp.	9	Lisle-Matrix	16
Axiom Technologies Ltd.	37	Mac-Weld	60
Baker Instruments	4	Milltronics	16
Bestobell Canada	62	Moore Products Co. (Canada) Inc.	23
Brian Controls	6	Novatech	10
Cambridge Controls	27	Phoenix Contact Ltd.	36
Campbell Scientific	20	Professional Valve	49
Cancoppas Ltd.	48	Prosigma Analytics Inc.	21
Cantech Controls	35	Provincial Controls	59
Cantrols	42	R.A. Kirby Sales Inc.	55
CTH Industrial Controls	26	Regional Process Equipment	8
CB Engineering	24	Romatec	18
CEM Specialties Inc.	15	Rosemount	54
Contro Valve Inc.	33	Samson Controls Inc.	25
Davis Controls	35	Sarnia Piping Specialties	32, 57
Durham Instruments	55	Semac Power & Controls	20
Dräger	21	Sharp Valve	7
Elsag Bailey Inc.	13	Southwest Meters	4
Endress & Hauser	8	Spec (Sarnia) Ltd.	44
Farris Industries	57	Spirax Sarco	15
Fisher Service	62	Summit Controls Ltd.	58
Floval Equipment	39	Syber Systems	44
Fryston Canada	45	Technorth Canada	35
Great Lakes Industrial Controls	2	Transcat	19
HCS Heating & Control Systems	51	Tubetech Ltd.	12
Hardie Industrial Supplies	16	United Electric	19
Honeywell Ltd.	63	Utility & Industrial Supply	13
Huron Valve	22, 78	Veronics Instrument	4
ICS - Triplex	50	Wesco Industrial Control Products .	40,41
IMO Industries	38	Westburne Lytle	12
Industrial Projects Ltd.	38	Westech Industrial	56, 61
Industrial Technical Services	22	Wika Instruments	22
Intertec Instrumentation	7	Willer Engineering	48
ISA Distribution Centre	60	Zirco	43
J&M Engineering	49		

INSTRUMENTS

VERONICS INC.

MOISTURE ANALYSIS

- Microprocessor Based
- Levels from 1 ppb
- Enhanced Response
- On-Line Analysis
- Liquid Hydrocarbon Service
- Portable Systems

GAS ANALYSERS

- Flue Gas
- Oxygen (ppm to 100%)
- Carbon Monoxide
- Carbon Dioxide
- Portable and Continuous
- Custom Systems

FLOWMETERS

-Ultrasonic

- Portable and On-line
- Liquid and Gas Phase
- Single and Multichannel
- CEM Flowmeters
- Flare Gas Meters

-In-Line

- Turbines
- Contact Head
- Paddlewheels
- Low Flows (0.05 GPM)

WASTEWATER ANALYZERS

- TC/TOC/TOD/Titrators

260 WYECROFT ROAD, UNIT 15
OAKVILLE, ONTARIO L6K 3T7
TEL (905) 842-5664 FAX (905) 842-0540

500-7675 ROUTE TRANSCANDIENNE
ST-LAURENT, QC H4T 1V6
TEL (514) 336-9482 FAX (514) 747-1717

BAKER INSTRUMENTS LIMITED

42 DUFFLAW RD., TORONTO, ONTARIO M6A 2W1
1-800-561-8187 FAX: (416)781-9484

ALNOR



VELOMETERS - DEWPOINTERS - THERMOMETERS - PYROMETERS
DEAD WEIGHT TESTERS - TEMPERATURE CONTROLS
LOW PRESSURE DIFFERENTIAL PRESSURE SWITCHES, GAUGES, MANOMETERS
DIFFERENTIAL PRESSURE TRANSDUCERS - MAGNEHELIC GAUGES - ANALOG & DIGITAL TACHOMETERS
TEMPERATURE, PRESSURE & FLOW RECORDERS
ROTOMETERS, ORIFICE PLATES & FLANGES, OPEN FLOW MEASUREMENT

OVER SIXTY YEARS *servicing industry in Canada*

SOUTH-WEST METERS LIMITED

P.O. BOX 1083
765 EVETT STREET
SARNIA, ONTARIO N7S 5N3
BUS: (519) 336-8628
FAX: (519) 336-9082

"WE MEASURE UP TO YOUR STANDARDS"

Shop and Field Services Provided:

- Certified Meter Proving & Repair
- Instrument Repair
- Liquid Transfer Systems
- Weight & Measures Calibration
- Preventative Maintenance Programs
- Tank Level Equipment

Contents

ISA Mission Statement	7
President's Corner	11
Sarnia Section Executive	14
ISA Member Benefits	26
Reduction in Flow Measurement Uncertainty	28, 29, 30
Log On To The World	32
ISA Perspectives	31, 34
Fieldbus Today... Resources on the Web	46, 47
Internet Rates & BBS Update	52
News Release	53
Thoughts to Get You Through Any Crisis	64
ISA Membership Application	65
User's Directory	66
Past President's Honour Roll	79

Editor's Notes

ADVERTISERS: Please note that the deadline for the SEPTEMBER ANNUNCIATOR is August 15, 1997. Please forward information to the editor by that date in order to have items updated.

**THE DINNER MEETINGS FOR THE 1997/98 SEASON
WILL BE HELD AT THE
SARNIA GOLF AND CURLING CLUB**

ISA Sarnia Section
Box 206
Sarnia, Ontario N7T 7H9

ISA Sarnia Section BBS
(519) 541-0427

Solutions in Measurement & Control

Process Control - Calibration and Test Equipment

Measuring Instrumentation (for flow, level, pressure, temperature, pH, ORP, conductivity)

Safety and Environmental (gas detection, gas analyzing, CEM and ambient air quality monitoring)

AMETEK

Pressure and temperature gauges, diaphragm seals, deadweight testers, pressure and temperature calibrators, transducers and transmitters

ASD

Advanced Sensor Devices, Inc.

CEM monitoring systems



Gas analyzers



Manifold valves; gauge and needle valves

CONTROL MICROSYSTEMS

Remote monitoring and control, telemetry and communication products, SCADA systems.

COSA

Gas oxygen analyzers

DELTA III

Flow switches; level switches

Digitec

Digital process indicators; signal conditioning, alarms



Rupture discs, explosion vents

GEORGE FISCHER +GF+ SIGNET

Actuated valves, pressure regulating valves, flow instrumentation

HETLAND

Flow metering systems

Honeywell

Pressure, level, flow, and temperature transmitters, controllers, recorders, digital control programmers, control valves

INDUSTRIAL SCIENTIFIC CORPORATION

Portable and fixed gas detection

J-TEC

Vortex flowmeters

KEAP

Batch controllers, flow totalizers, timers and counters

KEITEM

Variable area flowmeters, turbine meters

KURTZ

Gas mass flow measuring systems

McCROMETER

Primary flow elements, differential pressure flowmeters



Manometers; flow elements; flow and pressure calibration

Mid-West Instrument

Differential pressure indicators and switches



Ambient air analyzers

PERKINELMER, INC.

Jet pumps; sight flow indicators; level gauges and indicators; thermocouples and RTDs



Radar level / tank gauging

SPARLING

Magnetic flowmeters



Bimetal and gas actuated thermometers

UE

Pressure and temperature controls

Sales, service, and distribution across Canada since 1956
stocking warehouses • on-line computer system • order tracking
specialized shop services • calibration services traceable to N.I.S.T. • field start up services

ONTARIO REGION

Sarnia

tel.: (519) 337-7591 fax: (519) 336-0997

Mississauga

tel.: (905) 813-8310 fax: (905) 813-0570

or toll free: 1-800-313-3103

BRIAN CONTROLS

A DIVISION OF **PEACOCK**

A WEIR GROUP COMPANY

SHARP

VALVE & INSTRUMENTATION INC.

SARNIA – MISSISSAUGA

Official and Authorized Representatives for:
ROCHESTER INSTRUMENT SYSTEMS, LIMITORQUE, FIKE,
SHAND & JURIS, L&J TECHNOLOGIES, RESISTOFLEX,
WIKI, HEX VALVE, KOMAX HEATERS, DURABLA,
LUDLOW-RENSSEALER

PHONE: (519) 336-8484

FAX: (519) 336-0928

**1407 PLANK ROAD
SARNIA, ONTARIO**

COMPLETE PRESSURE RELIEF, BALL, GATE, GLOBE, PLUG,
BUTTERFLY, CONTROL VALVE AND ACTUATOR REPAIR.
FULL CALIBRATION SERVICE.

INTERTEC

 **FURON
UNITHERM**

ENCLOSURES CABINETS HEATERS MANIFOLDS
PRE-INSULATED & TRACED BUNDLE

INTERTEC INSTRUMENTATION LTD., 400 MOROBEL DRIVE, MILTON, ONTARIO. L9T 4N6
TELEPHONE (905) 875 4727 FAX (905) 875 4729
REPRESENTED BY NORTHERN ABCOR PROCESS EQUIPMENT & CONTROLS
TELEPHONE 1 800 547 4443

ISA's Mission

*To be the foremost worldwide society with
the science and application of measurement
and control technologies, and to advance
members' competence, professionalism, and
recognition.*

Endress + Hauser
Measurement for Automation



FLOW



Electromagnetic
Flowmeters, straight-tubed
Coriolis Mass Flowmeter,
Vortex Meter with E + H
patented DSC sensor.

Level detection and
measurement by:
Conductivity, Vibronics,
Capacitance, Hydrostatic,
Ultrasonic & Microwave -
the *widest* choice by any
manufacturer.

LEVEL

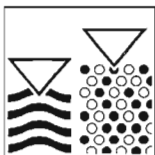

WATER

ANALYSIS

pH/Redox
Conductivity
Turbidity
Dissolved Oxygen
Chlorine

PRESSURE

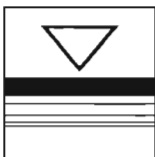

Cerabar family of Smart
Pressure Transmitters &
Switches, Deltabar Smart
Differential Pressure
Transmitters with self-
checking ceramic cell.

MOISTURE



Full range of Hygrometers and
Relative Humidity Meters using
polymer and smart aluminum
oxide sensors for all your
moisture measurement needs
in both gases and liquids.

**For sales and support call
Regional Process Equipment**

**Sarnia
(519) 337-7758**



REGIONAL PROCESS EQUIPMENT

Xomox Tuflin Sleeved & fully lined
Plug Valve, Pliaxseal High Performance
Butter fly, lined Port Valves, Matrix Actuators

KTM Ball Valves 2 ways reduced &
Full Port, 3 ways Hi- Temp Gratite Seats,
Metal Seated, Exxon Approved.

Orbe Knife Gates Valves Ansi # 150 lug,
or flanged Knife gates 2" to 72" Diameters, 316
S.S. 254 SMO, Titanium, Cast Iron

Valvtechnologies Inc. High Performance
metal seated ball valve RC 73 Rockwell,
Electronic Pressure Relief

Senior Flexonics Custom Metal Flex
hoses, Chlorine & Chemical Transfer Flex hoses,
Fabric & Metal Expansion Joints

INSTRUMENTATION

Endress + Hauser Canada. Level
Instruments, Pressure & Microwave. Flow
Instruments, Pressure Instrumentation

Crowcon Gas Detection Multi point Fixed
Systems. Personal & Portable Gas Detection

Wika Instruments Canada Pressure &
Vacuum gauges, Trend Bimetal, Vapor & Gas
Acturated Thermometers, Pressure Transmitters &
Transducers, Diaphragm Seals & Filling,
Thermowells & Protection Tubes

Fairchild Transducer & Regulators small
Modular Transducers, Non position sensitive
resistant to high vibration, CSA, Explosion Proof

**ASK ABOUT OUR COMPLETE VALVE
AUTOMATION SERVICE**

777 Campbell Street, Unit #2. Sarnia, Ontario
PH: (519) 337-7758 PH: (519) 337-7933

Regional Process Equipment

777 Campbell Street, Unit #2, Sarnia, Ontario, N7T 2J7
PH: (519) 337 7758 FAX: (519) 337 7933



Ball Valves

- ISO 9000 certified
- Exxon approved
- Nace Trim
- API 607 certified
- Metal Seat-High Temp
- 3 way, 2 & 4 seat



*** NOW STOCKED IN SARNIA***

Tong Yung Gates Globes & Check Valves

- ISO 9000 Certified
- Exxon & API 607 approved
- Nace Trim
- ANSI 150#, 300, & 600#

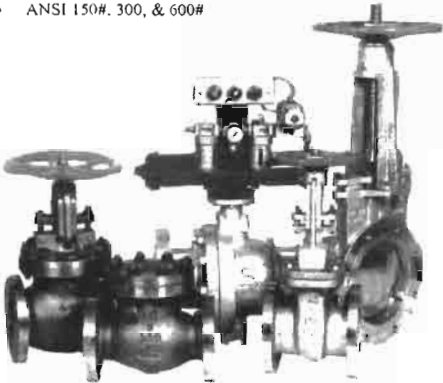

Full Automation & Control Services



Associated Valve

*** NOW AVAILABLE FULL AUTOMATION ***

Montreal

5600 Cypriot
 Ville St-Laurent (Quebec) H4S 1V7
 Tel.: (514) 339-5374 Fax: (514) 339-1550
 Technical Support 1-800-465-5374
 E-mail: novatech@netcom.ca











Instrumentation • Process • Environment



Toronto

160 Wilkinson Road, Unit 38
 Brampton (Ontario) L6T 4Z4
 Tel.: (905) 453-7224 Fax: (905) 453-2464
 Technical Support 1-800-465-5374
 E-mail: novatech@netcom.ca



GAS ANALYSIS

<p>1</p>  <p>Servomex LEADERS IN GAS ANALYSIS</p> <p>Paramagnetic and zirconia oxygen analyzers. Photometers for stack and process. Continuous Emission Monitoring Systems (CEMS).</p>	<p>8</p>  <p>Toxic and combustible gas detection. Ultrasonic flow and level monitoring. Water quality analysis.</p>
<p>2</p>  <p>Environmental Technologies Group, Inc.</p> <p>Open path FTIR systems. Detection of metals in water.</p>	<p>9</p>  <p>Molecular Analytics, LLC</p> <p>Ion-mobility spectrometers for emission, process and ambient monitoring.</p>
<p>3</p>  <p>Baldwin Environment, Inc.</p> <p>Sample conditioning systems for: CEMS, both portable and fixed. Sample probes.</p>	<p>10</p>  <p>Trace level gas moisture analyzers. PPB, PPM detection levels. Portable and fixed analyzers.</p>
<p>4</p>  <p>GASCO GAS ANALYSIS SYSTEMS COMPANY, INC.</p> <p>Portable FID/GC In-door air quality.</p>	<p>11</p>  <p>madur ELECTRONICS</p> <p>Portable stack monitoring analyzers.</p>

LIQUID ANALYSIS

<p>5</p>  <p>TYTRONICS INCORPORATED</p> <p>On-Line process titrators, colorimeters, and photometers. TOC analyzers.</p>	<p>12</p>  <p>Industrial process pH, conductivity, ion-selective electrodes and transmitters.</p>
--	---

GENERAL PRODUCTS

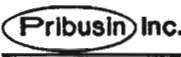
<p>6</p>  <p>Chemical metering pumps, controllers, and accessories.</p>	<p>13</p>  <p>Sensortech Systems Inc.</p> <p>On-Line moisture measurement in solids. Utilizing radio-frequency principle.</p>
<p>7</p>  <p>NOVATECH Engineering Group</p> <p>Customized systems integrators. Application engineering, technical support. Sample multiplexing systems. Continuous Emission Monitoring Systems.</p>	<p>14</p>  <p>Pribusin Inc.</p> <p>Signal conditioners, isolators, alarm modules, and multiplexers. Linearizers, integrators, and transmitters for frequency, temperature, and strain gauges.</p>



The International Society
for Measurement and Control



Outgoing President's Message

As the out going President this will be my last message during my term of office. During the year I have emphasized many times the importance of strengthening our membership. Membership is rather important to any organization and we, the Sarnia Section of the ISA, is not an exception. We need members who are willing to learn about the ISA and provide leadership and communication to the members and community. Again I ask anyone of our members who wish to pursue the challenge of leadership development to step forward as there are some positions that open to complete our full slate of officers.

We had a good year, we had good executive meetings with specific goals and we focused our energy to meet our goals. Our Newsletter has done an excellent job establishing a profitable newsletter, but to maintain this ideology we need more articles of interest for the members. We had well attended training seminars put on by our Education Committee. Our Show Committee has done an excellent job in achieving a successful show. The golf committee has proven to provide another successful event.

To the executive and committee members, I thank you for your support. The success for this year would not have been possible without all your help and the team action that was evident throughout the year, it made my job enjoyable and easy.

At our Awards Dinner we gave out Past President pins, Senior Member pins and honoured each executive member and committee with an ISA embroidered jacket. It is a small way to recognize such dedicated work. To the community, we have donated to the Sarnia and District Children Treatment Centre \$5000 for audio equipment for testing the children's hearing in the Sarnia area.

My term is not finished with the ISA, I will be working as the Section's Delegate and I will be re-writing our constitution and bylaws to be in line with the main organization's bylaws.

I ask all of you to give your new executive and new President, Andy Tucker your full support in providing a successful year.

Regards,

Randy Dennie, *Immediate Past President*

TubeTech Ltd.

Instrumentation
and Fluid Control

829 Phillip Street
P.O. Box 968
Sarnia, ON N7T 7K3

Tel: (519) 344-5271
Fax: (519) 344-8334

BAILEY
RISCHER
PORTER **P**

OHMART VEGA

**ALLWAY
SENSORS**

Hartman
& Braun

ASCO

Barksdale

Parker
Fluid Connectors

TLV

Bailey

Customer Service is our best product !



WESTBURNELYTLLE



INDUSTRIAL PRODUCTS DIVISION
SARNIA

- A.S.I.** – Multipoint Level Indicators
- ASCO** – Solenoid Valves, Pressure and Temperature Switches
- CASH-ACME** – Reducing and Regulating Valves
- CLIF MOCK** – Liquid and Gas sampling systems, Liquid P.D. meters
- DOPAK** – Process Samplers
- EL-O-MATIC** – Actuators, Positioners, Switches, etc. for Quarter Turn Valves
- E.V.I.** – Engineered Ball Valves for Special Applications
- GGOSCO** – Needle Valves
- KAMMER** – Control Valves for Special Applications
- PROMAG** – Magnetic Liquid Level Indicators & Continuous Level Transmitters
- TRICENTRIC** – Metal Seated, Class VI, Butterfly Valves
- VELAN** – Ball Valves - Cryogenic, Metal Seated, Resilient Seated

1231 Confederation Street , Sarnia, N7S 4M7
Telephone: (519) 336-0014 Fax: (519) 336-7396



Elsag Bailey

Elsag Bailey (Canada) Inc.

134 Norfinch Drive, Toronto, Ontario M3N 1X7
Telephone: (416) 667-9800 / 1-800-663-7097/Fax: (416) 667-9816

Bailey

TRANSMITTERS, RECORDERS, CONTROLLERS & ANALYZERS
For temperature, flow, level, combustion & emissions

BAILEY
FISCHER
PORTER **P**

MAGNETIC FLOWMETERS, MASS FLOWMETERS, ROTAMETERS,
LEVEL INDICATORS, VORTEX METERS, FLUMES, ULTRASONIC
LEVEL/FLOW & CONTROLLERS

TBI-Bailey

SENSORS, INDICATOR/ANALYZERS & CONTROLLERS
For pH, ORP and conductivity

PRODUCTS REPRESENTED EXCLUSIVELY BY:

TubeTech Ltd.
829 Phillip Street
P.O. Box 968
Sarnia, ON N7T 7K3

Tel: (519) 344-5271
Fax: (519) 344-8334

U&I SUPPLY

UTILITY & INDUSTRIAL SUPPLY LTD.

645 Keddco St., P.O. Box 999

Sarnia, Ontario N7T 7K6

Phone: (519) 344-3614 Fax: (519) 344-3181

Chemtrol
A DIVISION OF NIBCO INC.

Kaynar, PVC, CPVC, Ball,
Check, Butterfly,
Valves & Actuators



IMPERIAL EASTMAN

Tube Fittings, Including
Hi-Seal, Braze-Seal, Hi Duty,
and Poly-Flo, Tubing & Hose

**KEDDCO
MFG. LTD.**

Orifice Plates, Spectacle
Blinds, & Strainers

Stewart R. Brown

Static Bonding Equipment,
Bonding Reals, Lights



A.C. Invertors, D.C.
Controllers, Softs Starts

**Worcester
Controls**

Advanced Ball Control
Valves, Electrical &
Pneumatic Actuators,
Controllers, Positioners, &
Fugitive Emission Valves

SCULLY

Level Probes, Sensors &
Monitoring Scul-Tel System

SIMCO

Liquid Level Gauges &
Valves

Sarnia Section Executive 1997-98

Position	Incumbent	Phone	Fax
		(Area Code 519)	
President	Andy Tucker	383-3704	383-8285
Vice-President	TBA		
Past President	Randy Dennie	337-8252 ext.5871	339-7723
Education Chairman	Kalpen Vachharajani	332-0160 ext. 281	332-1186
Treasurer	Jeff Talbot	344-5271	344-8334
Assistant Treasurer	TBA		
Executive Assistant	TBA		
Newsletter Chairman	Bob Devine	332-2300	332-6640
Newsletter Editor	Brad Simpson	337-3200	337-7068
Newsletter Assistant	Rob Thrift	336-0201	336-0209
Web Master	Brian Smith	332-1212 ext. 7920	339-7301
Program Chairman	Chuck Douglas	344-5271	344-8334
Program Assistant	Glen Williamson		
Honours & Awards Chairman	Aldo DeSantis	344-4300	344-0042
Honours & Awards Assistant	Guy Salt	344-4300	344-0042
Membership Chairman	Jennifer Southcombe	337-2301 ext. 480	332-3309
Membership Assistant	Mike Murray	383-1709	339-0841
Student Section Liaison	Mike Grey	542-7751 ext.308	542-6667
Standards and Practices	Don Murch	431-1916	431-1127
Standards and Practices Asst.	Umesh Patel	339-9701	339-9702

CEMs for COMPLIANCE or PROCESS CONTROL?

CEM Specialties Inc.

tel: (519) 641-6431
fax: (519) 641-6536
admin@cemsi.on.ca
<http://www.cemsi.on.ca>

NOx SO2
CO2 TRS Hg
THC O2
CO
HCl NH3



'SPECIALISTS IN
CONTINUOUS EMISSIONS MONITORING'

- Discrete Gas Analyzer Systems
- Bodenseewerk/Perkin Elmer Analyzer Systems
- Sampling Probes and Heated Umbilicals
- FID Analyzers (Portable / 19" Rackmount)
- M&C Products Gas Conditioning Systems
- Opacity and Dust Concentration Monitors
- QA/QC Plans

Working towards ISO 9001 Registration

spirax / sarco

If it is a Question of...

HEAT TRANSFER, FLUID CONDITIONING, MONITORING, METERING AND/OR CONTROL, THEN SPIRAX SARCO CANADA CAN HELP YOU FIND THE ANSWER!

PHONE FOR YOUR GUIDE TO IMPROVING PLANT PROCESS AND ENERGY EFFICIENCY.

(905) 660-5510 Ask for Carol

ARMATEK CONTROLS LIMITED

**PROCESS INSTRUMENTS
SALES AND SERVICE**

ARMATEK - Instrument Accessories
CELLEX - Instrument Heating Specialists
DELAVAN - Level Instrumentation
FLUID DATA/AMSCOR - Analytical Instruments
GREAT PLAINS INDUSTRIES - Digital Flow Meters
ITT BARTON - Industrial Instruments

MESA/NUSONICS - Ultrasonic Instruments
MOORE INDUSTRIES - Electronic Modules
PHASE DYNAMICS - Microwave Process Analyzers
ROHRBACK/COSASCO - Corrosion Monitoring
TELEDYNE ANALYTICAL - Gas Analyzers
THERMO ELECTRIC - Temperature Specialists

Tel: (519) 332-0100 Fax: (519) 332-8821

Serving the Process Industries since 1966

LISLE-METRIX LTD.

49 Sheffield Street, Toronto Ontario M6M 3E5
Telephone: (416) 249-9151 Fax: (416) 249-2952

WATER QUALITY ANALYZERS - pH, ORP, Conductivity,
Dissolved Oxygen, Turbidity

FLOW METERS - Area, Doppler, Flume, Impeller, Mass,
Nozzle, Thermal, Turbine, Venturi

PROCESS PHOTOMETERS - Dust, Oil-In-Water,
Ozone, Turbidity, Colour, Nitrate, Dissolved Organics,
Solvents in Effluent, Water in Organic Solvents

LEVEL SENSORS - Conductance, Magnetic Coupled

I.S. BARRIERS, ISOLATORS, LOGIC CONTROLS

PROXIMITY SWITCHES - Capacitive, Inductive, Optical,
Ultrasonic, Magnetic, Photoelectric, Fibre Optic

PANEL INDICATORS & CONTROLLERS



HARDIE INDUSTRIAL SERVICES INC.

Representing

GGOSCO
Custom Ball Valves

KINETROL
Actuators

Instrumentation/Electrical Installations • Process Design • Project Management
Contract Maintenance • Sales & Service
Phone: (519) 649-1433 Fax: (519) 649-6559
London, Ontario



Technology Works!

In Process Measurement Systems



- Ultrasonic Level Measurement



- Belt Scales/Flowmeters



- Stresswave Sensor



- Motion Sensors

Milltronics offers products for non-contacting ultrasonic level measurement for solids and liquids at ranges up to 60 m; single and multi-idler conveyor belt scales for weighing material moving on conveyor belts; dry solids flowmeters for continuous in-line weighing; and process protection equipment including flow/no flow switches and motion sensors.

For more information, Contact:

Milltronics Ltd.

P.O. Box 4225,

Peterborough, Ontario K9J 7B1

Tel: (705) 745-2431 Fax: (705) 745-0414



INSTRUMENTATION INC.

THE WORLD LEADER IN THE DESIGN AND MANUFACTURE OF INSTRUMENTATION

SMART TRANSMITTERS
MASS FLOWMETERS
INTEGRAL ORIFICE ASSYS
CONTROLLERS

MAGNETIC FLOWMETERS
WEDGE FLOW ELEMENTS
RECORDERS
ZIRCONIA OXYGEN ANALYZERS
PACKAGE BOILER CONTROLS

ADVANCED CONTROLLERS
WATER ANALYZERS - pH, CONDUCTIVITY, DISSOLVED O2, TURBIDITY
AMMONIA, FLUORIDE, NITRATE, SILICA, PHOSPHATE ANALYZERS

GAS CHROMATOGRAPHS, INFRARED & ULTRAVIOLET PHOTOMETERS
ABB EXTREL MASS SPECTROMETERS

TO CONTACT YOUR LOCAL REPRESENTATIVE CALL

SARNIA - PHONE (519) 541-0011 FAX (519) 541-0012

LANGTREE CONTROLS LTD.

P.O. Box 2326
509 South Vidal Street
Sarnia, Ontario
N7T 7S6
Phone: (519) 344-6868
Fax: (519) 344-7944
E-Mail: langtree@sarnia.com

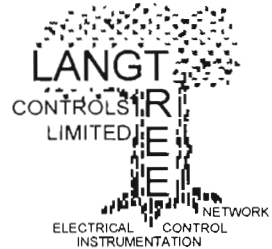

INSTRUMENT & ELECTRICAL DESIGN ENGINEERING

Services

Feasibility Studies
Budget Preparation
Detailed Engineering
Project Management
Field Co-ordination
AutoCad / Microstation PC

Experience With

Control Panel Design / Layout
Instrument Installation Details
Marshalling Rack / Field Wiring
MCC Design / Layout
Motor Control & Protection
Variable Speed Drives

THE "ROOT" TO QUALITY ENGINEERED CONTROLS !



romatec

1173 Michener Ct., Unit #1
P.O. Box 2110
Sarnia, Ontario N7S 5G5
Tel.: (519) 337-7416
Fax: (519) 336-0998
Inwatts: 1-800-268-3137

Serving Canada's Process Industries Since 1955

NASHCROFT

- Pressure Gauges



JACOBY-TARBOX

- Sight Flow Indicators

Bellofram

- Transducers
- Regulators



- Opacity Monitors and Combustion Analyzers



SAFETY SYSTEMS

- Rupture Discs

Pulsafeeder

- Metering Pumps



DELPHIAN

- Combustible Gas Monitors

ROSEMOUNT

- Combustion Controls



- Liquid Level Gauges
- Eductors

TN Technologies

A Thermo Instruments Company

- Radar, Nuclear & Ultra-sonic Level Controls

Also...

APOLLO • ITT • KOCH • 3P • TBV

GIVE 'EM HELL.



UNITED ELECTRIC PRODUCTS ARE BUILT TO TAKE IT.

Look to us for pressure and temperature switches, temperature sensors, transmitters and thermostats that meet your most demanding requirements in your most demanding environments. Our new product innovations include epoxy coating for wider NEMA 4/4X and corrosive locations, flush mount and ultra low, all welded pressure sensors as well as corrosion resistant transmitters. A diverse growing line to meet your exacting specifications.



**QUALITY LIKE THIS IS NO EMPTY PROMISE.
PUT US TO THE TEST.**

Call United Electric Controls at 905/625-5082.

United Electric Controls (Canada) Ltd. Tel 905/625-5082 Fax 905/625-5799



Unleash The Unlimited Resources Of The Cat.

It's easy to receive a free copy of Transcat's new comprehensive, full-colour 1997 catalog of Test, Measurement and Calibration Instruments. Just call us at **800-828-1470**.

TRANSCAT

The Unlimited Resource

SEMAC POWER & CONTROLS LTD

Custom Electrical / Mechanical Panel Shop
C.S.A. / U.L. Certified – I.B.E.W. / U.A.
Instrument / Control Technicians / Electricians
Installation / Service / Analyzer Shelters
PLC Controls / Scada / DCS Controls
High Voltage and Control Systems
24hr Emergency Service Available / Contract Basis
Competitive Pricing Market Researched

525 Vidal S. Sarnia (519) 336-5986
Fax Sarnia (519) 336-4490



Campbell Scientific (Canada) Corp. Data Acquisition

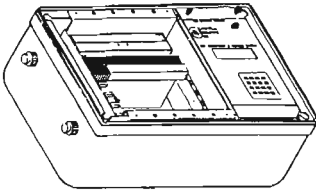

CR7

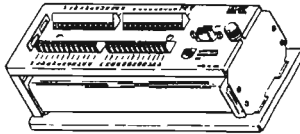

CR10

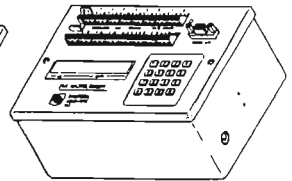

21X

MEASURING: Temp Probes. Load Cells. Relays. Flow Meters. 4-20mA Transducers
Strain Gauges. Analog. Digital. Pressure Transducers. Meteorological Sensors

On Site Demonstrations Available

Est. 1978

192 st clair str. chatham, ontario N7L 3J6 (519) 354 7356 fax (519) 354 1558
11564 149 str. edmonton, alberta T5M 1W7 (403) 454 2505 fax (403) 454 2655



PROSIGMA

Process Analyzers-Analyseurs de procédés

Elsag Bailey Analytical Division



Opacity Monitors
In-Situ CEM Systems
Combustion Monitors
Cross Stack CO Analyzers
UV/IR Process Photometers
Portable Flue Gas Analyzers

BOMEM

Process FTIR Analyzers
Extractive FTIR CEM Systems



Delta F Corporation

Oxygen Analyzers

zellweger analytics

astro

TOC Analyzers

polymetron

pH, Conductivity,
Silica, Oxygen, Sodium,
Chlorine, Ozone, Hydrazine,
Phosphates, Nitrates, Titrators

BTG polymetron

Turbidity Analyzers
Suspended Solids Monitors



Innovative Sensors, Inc.

Industrial pH/ORP Sensors



Transportable CEM Systems
Low Cost CEM Systems

AEM SYSTEMS

Sampling Systems for
Liquid and Gas : Process,
Effluent, Boiler Feedwater,
Ambient Air and Emission

PROSIGMA ANALYTICS INC.

Toronto

4141 Dixie Road,
PO. Box 61
Mississauga
Ontario L4W 4X9
Tel.: 905 206 0921
Fax.: 905 206 1361

Montréal

1051 Ave. St-Charles,
Suite 106
Vaudreuil-Dorion
Québec J7V 8P5
Tél.: 514 455 8185
Fax: 514 455 8984

Dräger

Gas Detection

Stationary Systems

Toxic Gases and Vapours

CO, H₂S, CL₂, CO₂, NH₃, O₂
HCL, HCN, NO₂, PH₃, SO₂
and many others

Combustible Gases

Methane, propane, solvents;
over 400 different gases



Portable Monitors

Single and multi-gas monitors;
Evaluate worker exposure;
Confined space entry



Dräger Tubes

Detect over 500 different gases
quickly, simply, accurately



Dräger CMS

Revolutionary measurement system,
gas testing on a Chip

Draeger Canada Ltd.

7565 Danbro Crescent
Mississauga, Ontario L5N 6P9
Tel. 905-821-8988 Fax 905-821-2565

INDUSTRIAL TECHNICAL SERVICES



Dedicated/multi-function calibrators for every application. Low cost, easy to use, measured/ simulated, LCD display, I.S. models.

J.U.M. Heated Hydrocarbon analyzer for high accuracy, sensitivity and stability. Methane and non-methane.

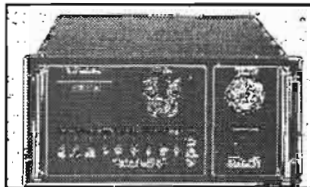

Magnetic modulating control valve:
 * 4-20 mA/0-10 DC in.
 * Fast acting
 * High turn down
 * Water/steam
 * Refrigerants



Zirconat Oxygen Analyzer

Small detachable sensor for easy serviceability. Microprocessor analyzer. Temps. to 2900°F. Combustion efficiency & RS485.

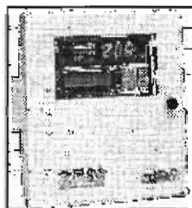

2395 Cawthra Rd., Unit 8, Mississauga, L5A 2W8 Ph:(905)275-2717 Fax:(905)275-2724 Toll Free: 1-888-487-8677
 Local Rep: BSP Instruments, Wallaceburg John Eyd Ph:(519)627-8505 Fax:(519)627-7016



WIKI INSTRUMENTS CANADA LTD.

Pressure, Vacuum and Specialty Gauges
 Pressure Transmitters and Transducers
 Digital Indicators, Chemical Seals



Precision General Inc.



Instruments, Inc.



- Needle Valves • Block and Bleed Valves • Mini Valves
- Manifold Valves • Direct Mount Manifold Systems

145 Mayfair Dr., Sarnia, Ontario N7S 1L3
 TEL: (519) 344-1339 FAX: (519) 344-1339

- Bimetal Thermometers
- Gas and Vapor Actuated Thermometers
- Thermowells

1535 Meyerside Dr., Unit 6, Mississauga, ON L5T 1M9
 TEL: (905) 795-1677 FAX: (905) 795-1669



P.O. Box 386
 Sarnia, Ontario N7T 7J2

JOE LAWLESS
 ED VANDEN EYNDE
 RANDY HADDON
 BRIAN DAVIDSON

Phone: (519) 336-3453
 Fax: (519) 336-1537

NEW... from Krohne!

EcoFLUX™ **Low-Cost, Wafer** **MAGMETER**

**UNCOMPROMISED QUALITY
AND PERFORMANCE...
AT VERY LOW COST**

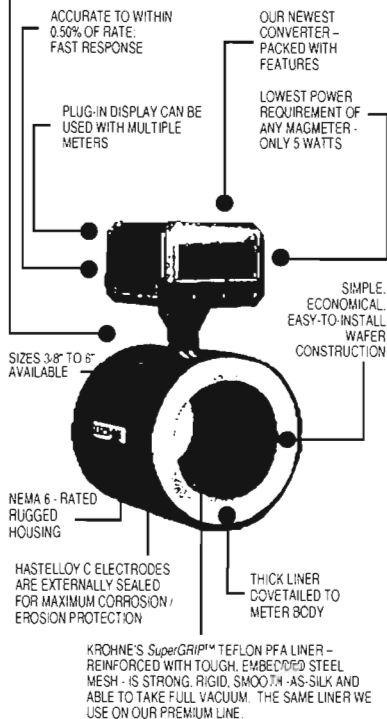

Food & Pharmaceutical **PROCESS LEVELS**



Krohne's New BM 70 Wave Stick

Here is a unique new, non-contact way to measure levels in closed process and storage vessels. Based on the widely used MB 70 LEVEL-RADAR gauge, the Wave Stick features a compact, tapered TEFLON PTFE probe, and is ideal for use in food and pharmaceutical processing applications.

KEY FEATURES:

- All parts in contact with process & tank atmosphere made of food grade TEFLON PTFE
- Clean-In-Place / Steam-In-Place capability
- Suitable for tank height from 0 to 30 ft. Process Measurement to within 8" of vessel top.
- Easy to install - compact fittings (2" ANSI/ 3" Tri-Clamp)
- Radar-based system provides high accuracy measurement, even under difficult process conditions.
- Low power consumption.
- Furnished with remote configuration, providing for long-distance data transmission via smart digital interface.



For the latest in Flow & Level Measurement
call Moore Products Co. (Canada) Inc.
Canadian Distributor for Krohne.

P.O. Box 370 Brampton, ON L6V 2L3
Phone: (905) 457-9638 Fax: (905) 457-4182



CB ENGINEERING (EASTERN) LTD.

P.O. Box 2523
Sarnia, Ontario N7T 7H9
Tel: (519) 337-1350
Fax: (519) 337-3105
Sales & Service: 1-800-99-CBENG

OFFICES ACROSS CANADA
• CALGARY • SARNIA
• EDMONTON • TORONTO
• MONTREAL • VANCOUVER
• WINNIPEG



BLH Electronics Canada

FORCE AND WEIGHT MEASUREMENT.
BATCH/WEIGHT CONTROL SYSTEMS.
WEB TENSION MEASUREMENT & CONTROL.



INDUSTRIAL FIRE & GAS DETECTION SYSTEMS
HAZARD EVENTS MONITORING.
SLICKWATCH OIL SLICK DETECTOR.



ORIFICE PLATES, VENTURIS
FLOW TUBES, METER RUNS
FLOW NOZZLES

Intellution

PC BASED SCADA & MMI SOFTWARE FOR
32 BIT WINDOWS APPLICATIONS.
PC BASED REAL-TIME CONTROL SOFTWARE.



HIGH ACCURACY MAGNETIC LIQUID LEVEL
TRANSMITTERS.
SEAL FLUID SUPPLY TANKS (SEAL POTS).



PC BASED INDUSTRIAL AUTOMATION
SYSTEMS
INTELLIGENT MODULAR I/O



PC BASED REAL TIME CONTROL



KEYBOARD, VIDEO, MOUSE (KVM)
CONTROL AND ACCESS PRODUCTS



TURBINE METERS.
LOW FLOW METERS (0.001 GPM).
CALIBRATORS/FLOW PROVERS.



INDUSTRIAL COMPUTERS AND MONITORS
DATA COLLECTION SYSTEMS.



VORTEX/MASS/MAGNETIC FLOWMETERS.
RECORDERS/CONTROLLERS.
PRESSURE/TEMPERATURE TRANSMITTERS.
O₂/pH /ORP /D.O. /CONDUCTIVITY ANALYZERS.



INSULATED/HEATED INSTRUMENT
ENCLOSURES.
INSULATED/HEATED TUBING BUNDLES.



WIN 911 - ALARM REPORTER
EASYLINK - FACTORY FLOOR CONNECTIVITY
TO WINDOWS



PROGRAMMABLE CONTROLLERS
PANEL MOUNT INDICATORS & SWITCHES

Visit our Web Site: <http://www.cbeast.com>

Proud To Serve You Locally

SAMSON

1907 - 1997

Control Valves

Actuators

Valve Accessories

Steam Conditioning Stations

Process Instrumentation

Self Operated Regulators

Valve Repair Centre



24 HR DELIVERY AND SERVICE

SAMSON CONTROLS INC.

TOLL FREE 1-800-7-SAMSON

(1-800-772-6766)

Tel: (519) 464-6018

Fax: (519) 246-1460

SAMSON

You Can Depend On Us



CTH INDUSTRIAL CONTROLS ONTARIO LTD.
 45 Bramalea Road Suite 210 Brampton Ontario L6T 2W4
 Telephone (905) 792 6829 Fax (905) 792 6902



ACTION INSTRUMENTS

- Limit Alarms
- Signal Conditioners
- Transmitters
- Indicators

AFE Technologies Inc.

- Touch Screens
- Graphic Display Systems
- Datapanel



- Data Collectors and Loggers
- Smart Networked Signal Conditioners
- Multiplexers



**deltacon
INCORPORATED**

- Pressure Switches
- Temperature Switches
- Flow Switches
- Pressure Transducers

DIXSON, inc

- Indicating Bargraphs and Alarms
- Horizontal and Vertical Units
- Programmable Configurations
- Nuclear Qualified Indicators



- Weight Controllers
- Rate Controllers
- Batching Systems
- Load Cells



- Corrosion Proof Thermoplastic Products
- Manual & Actuated Ball Valves
- Manual & Actuated Butterfly Valves
- Single and Duplex Bag Filters



- Incremental and Absolute Encoders
- Linear Scale Encoders
- Single to Six Axis Controllers



SEMITRONIC

- Frequency Transducers
- Current Transducers
- Voltage Transducers
- Hall Effect Sensors



- Industrial Computers
- Shoebox Computers
- Operator Workstations
- CPU Boards 486 P5



- Single and Dual Loop Controllers
- Auto/Manual Control Stations
- Recorders



- DC Voltmeters
- Process Monitors
- Frequency Meters
- Counters



- Signal Conditioners
- Power Supplies



YOUR ISA MEMBER BENEFITS

You receive many benefits as an ISA member. In addition to developing valuable contacts with others in the instrumentation field through **Section Activities**, ISA offers . . .

Division Activities—An opportunity to join any of 24 technical interest divisions that keep you current in your particular field.

Directory of Instrumentation—A free annual guide of products, manufacturers, services, trade names, sales offices and more.

Standards and Practices—International industry guidelines that help improve performance and communication, reduce costs and promote safety. Free as issued.

Leadership Development—Educational programs and materials designed to enhance your leadership skills in preparation for Society and career advancement.

Instrumentation Publications—Over 400 publications and educational aids available at member discounts.

INTECH—The leading international journal of instrumentation that keeps you up to date every month— free.

Inside ISA—A free publication supplement that highlights member activities.

Technical Training Courses—An opportunity to update your technical skills at member discounted rates.

Symposia, Conferences, Exhibits—Forums that allow you to discuss practical applications with engineers, scientists, educators, researchers and technicians.

Peer Recognition—ISA honors and awards that acknowledge outstanding achievements.

Resume Referral Service—Free employment assistance to unemployed members.

Optional MasterCard, Insurance—An opportunity to get a MasterCard or sign up for supplemental insurance at low group rates.

FOR MORE INFORMATION ON ISA MEMBER BENEFITS, CONTACT:
Instrument Society of America

67 Alexander Drive, PO Box 12277 • Research Triangle Park, NC 27709 • (919) 549-8411



ControlAir Inc:



J.M. CANTY, INC.



PRODUCTS

- ACTUATORS
- AIR CYLINDERS
- ANNUNCIATORS
- BLEEDER CLEANERS
- BTU METERS
- CAMERA SYSTEMS
- CONTROL VALVES
- CONTROLLER (Batch)
- CONTROLLER (Pressure)
- CONTROLLER (Temp.)
- CONTROLS
- DIGITAL PROCESS INDICATOR
- ELECTRIC ACTUATORS
- FLOW INDICATORS
- FLOW MONITORS
- FLOW METERS
- FLOW SWITCHES
- FLOW TOTALIZERS
- FLOW TRANSMITTERS
- GRAPHIC DISPLAY
- INDICATORS
- INSTRUMENT AIR FILTER REG.
- ISOLATORS
- LEVEL INDICATION-CONTROL
- LIGHTING (Vessel)
- PIPE SPREADER
- PRESSURE BOOSTERS
- PRESSURE CONTROLLER
- PRESSURE INDICATORS
- PRESSURE REGULATORS
- PRESSURE SWITCHES
- PRESSURE TRANSDUCERS
- PRESSURE TRANSMITTERS
- REGULATORS
- RTD's
- SIGNAL CONDITIONERS
- SIGNAL CONVERTERS
- SIGHT GLASSES
- TEMPERATURE INDICATORS
- TEMPERATURE CONTROLLERS
- TEMPERATURE SWITCHES
- TRANSDUCERS
- TRANSMITTERS
- THERMOCOUPLES
- VISION SYSTEM (Camera)
- VALVE ACTUATORS
- VALVES (Backpressure Relief)
- VALVES (Control)
- VALVES (Regulators)
- WIND SPEED MONITOR



Contact the Newsletter Team for Details!

6 LANSING SQUARE, SUITE 120
 NORTH YORK, ONTARIO M2J 1T5
 PHONE: (416) 499-8904
 FAX: (416) 499-5381

Reduction in Flow Measurement Uncertainty by Real-Time Temperature and Pressure Compensation

Introduction

Even with the advent of several new technologies over the last two decades, head type flowmeters are still the most commonly used flow measurement device. This flow measurement technique creates a differential pressure across a restriction (e.g. orifice plate) in the flow channel.

The major limitation of the measurement technique is the low rangeability. A turndown of 3:1 is the convention for orifice meters. This is significantly lower than many of the newer technologies; vortex meters can achieve 38:1, and coriolis meters achieve 100:1. One way of achieving higher rangeability with head type meters is through real-time temperature and pressure compensation.

This paper presents results that show how real-time temperature and pressure compensation can increase rangeability.

Theoretical Background

The following equation describes the flow of a fluid through a restriction:

$$Q_m = NC_d E Y_1 d^2 \sqrt{\rho h} \quad (1)$$

where: Q_m = mass flow rate (mass/time)

N = units conversion factor (dimensionless)

C_d = discharge coefficient (dimensionless)

E = velocity of approach factor (dimensionless) $E = \frac{1}{\sqrt{1-\beta^4}}$ where $\beta = \frac{d}{D}$

D = meter tube bore (length)

Y_1 = gas expansion factor (dimensionless)

d = orifice bore (length)

ρ = fluid density (mass/volume)

h = differential pressure

In order to simplify the calculation, it is common practice to use the following equation for liquids:

$$Q_m = K_1 \sqrt{h} \quad (2)$$

and:

$$Q_m = K_2 \sqrt{\frac{hP}{T}} \quad (3)$$

for gases.

These simplified equations assume that most of the terms in the original equation are constant over the operating range. In fact, only the units conversion factor is constant, the remaining terms vary with operating conditions (temperature, pressure, and flow). By assuming that these parameters are constant, significant errors are introduced in the flow rate calculation.

(Continued on Page 29)

Tables 1 and 2 show the contribution that each of the terms in Equation 1 make to the overall uncertainty in the flow rate¹

Table 1: Contribution of Equation 1 terms on overall gas flow uncertainty.

Term	% Contribution
C_d	84.30
Y_1	2.73
D	3.32
d	6.06
h	0.33
ρ	3.26
Total	100

Table 2: Contribution of Equation 1 terms on overall liquid flow uncertainty.

Term	% Contribution
C_d	86.95
Y_1	0.00
D	3.43
d	6.25
h	0.34
ρ	3.03
Total	100

The above data shows that variations in the discharge coefficient are the major source of error. These errors can be reduced by real-time calculation of C_d , Y_1 , D, d, and ρ as they vary with operating conditions.

Improvements by Temperature and Pressure Compensation

By including real-time temperature and pressure compensation the performance can be significantly improved. Temperature and pressure compensation redistributes the sources of error; reduces the contribution by variations in the "constant" terms.

Figures 1, 2 and 3 show how the gas flow uncertainty is reduced with temperature and pressure compensation².

Conclusion

By incorporating real-time temperature and pressure compensation, the contribution to flow uncertainty of variations in parameters that are usually considered to be constants are reduced significantly. This reduction in uncertainty allows 8:1 rangeability with orifice type meters that were conventionally limited to 3:1.

¹ Wiklund D. E., and Englestad, L. M.: "Improving Flow Measurement by Real-Time Flow Calculation in Transmitters having Multiple Process Variables", *ISA New Orleans Conference*, 1995.

² Wiklund D. E., *ibid*.

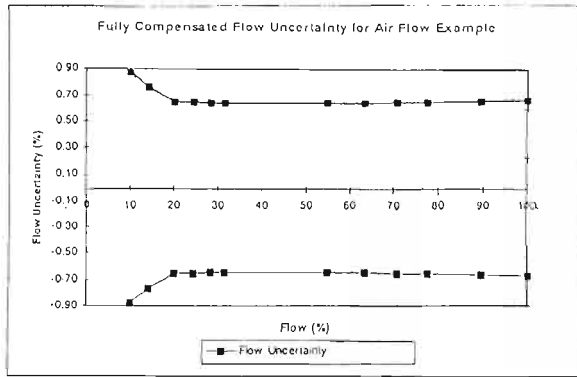

Figure 1. Flow Uncertainty vs. Flow Range (Fully compensated air flow)

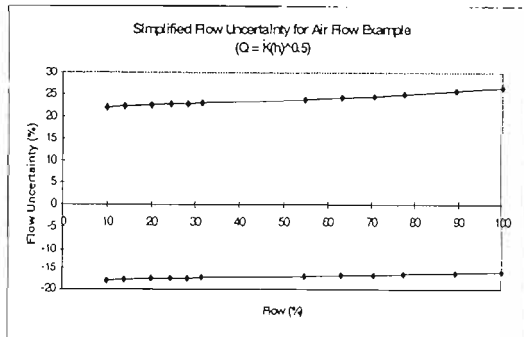

Figure 2. Flow Uncertainty using Simplified Flow Equation vs. Flow Range
 $(Q_m = K_1 \sqrt{h})$

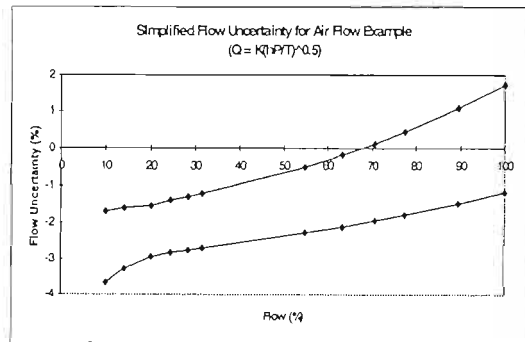
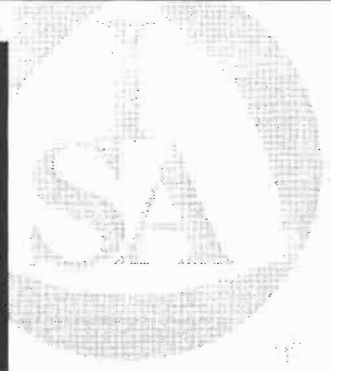

Figure 3. Flow Uncertainty using Simplified Flow Equation vs. Flow Range
 $(Q_m = K_2 \sqrt{\frac{hP}{T}})$

ISA PERSPECTIVES



Sarnia Section
**May
Dinner
Meeting**



LOG ON TO THE WORLD OF MEASUREMENT AND CONTROL

ISA ONLINE Now Available. Try It Today!

- Network with peers **WORLDWIDE.**
- Get answers to questions.
- Participate in forums.
- Find products and services to meet your needs...all from your keyboard.

ISA moves onto the information superhighway with on-line services with an exciting new communication channel - **ISA ONLINE**. Expand your knowledge and get to know your peers as you participate in technical forums. Build your own "network" through Internet e-mail. Find the training you need to stay competitive. Read the latest news for measurement and control by accessing *INTECH*, *Industrial Computing*, or *Motion Control* on-line magazines.

Find the new arenas for discussion in our calendar of industry events and meetings.

And there's much more.
**Dial in Today:
(412) WORLDISA**

ISA OnLine Connection Information
Telephone 412/967-5347
300-19200 Baud supported
8 bits, no parity, 1 stop bit
VT100, ANSI, RipScript terminal support
or Telnet to isa.industry.net



The International
Society for
Measurement
& Control

Need help? Call ANN (412) 967-3500 and ask for ISA Online Tech Support.

SARNIA PIPING SPECIALTIES LTD.,

765 EVETT ST. P.O. Box 2018, Sarnia, Ontario. N7T 7L5

Phone: 336-8820 Fax: 336-2033

..... OLIVER VALVES

..... BI-LOK FITTINGS

..... GO REGULATORS

..... BALSTON FILTERS

..... STATHAM TRANSMITTERS

..... SPS FIBRE FORM ENCLOSURES

..... SCHLUMBERGER FLOW METERS

..... ITT NEO-DYN PRESSURE SWITCHES

..... MANOUBOURDON PRESSURE GAUGES

..... ITT CONOFLOW TRANSDUCERS & REGULATORS

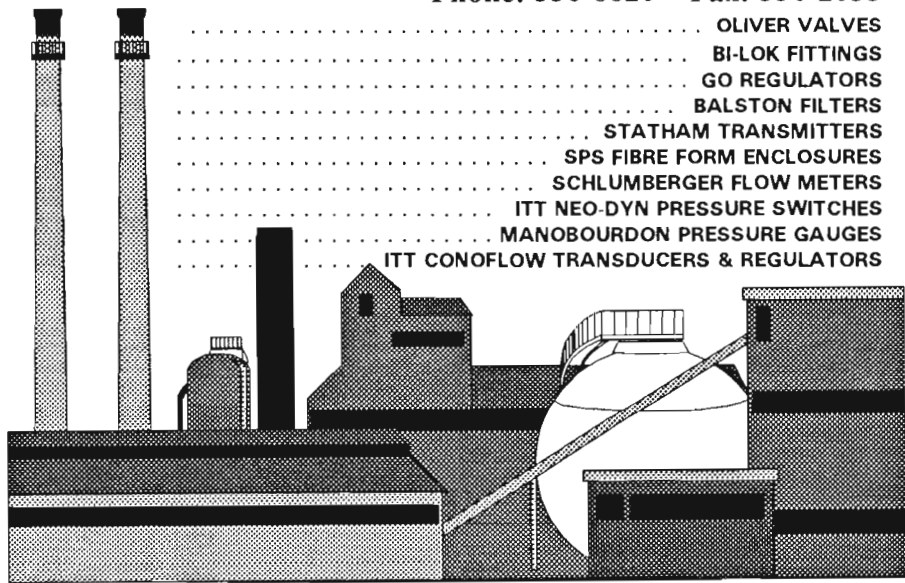

CONTRO VALVE INC. SERVICE & REPAIR CENTER

Contro Valve Inc. is your exclusive Dresser authorized full service MARC/GTC® Repair Center for all of your control and relief valve repair needs.



MARC Program - Masoneilan Authorized Repair Center

- Complete in-house or on-site repair or overhaul of all control valves
- Field Diagnostic Testing Unit for in-line control valve analysis



GTC Program - Green Tag Center

- Complete in-house or on-site repair for all pressure relief valves
- Electronic Valve Tester (EVT) for in-place valve performance analysis
- Field Reseating Machine
- Set and test facilities for air, liquid and steam service

Contro Valve is your source for Dresser's Masoneilan®, Consolidated®, Hancock®, Dewrance® and Nilcor® valves and instrumentation.



CONTRO VALVE INC

907 Michigan Avenue, Pt. Edward, Ontario N7V 1H2

Tel.: (519) 344-4300 or Fax: (519) 344-0042

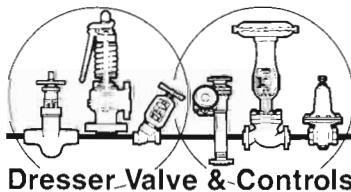

Dresser Valve & Controls

ISA PERSPECTIVES



Sarnia Section
**May
Dinner
Meeting**

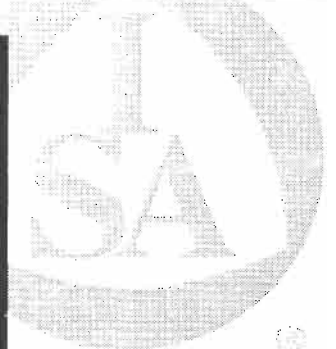

Autotech
BJ Software
Balluff
Barber Colman
Carlo Gavazzi-Dupline
Danfoss
Dwyer
Dynapar
Eagle Signal
Electromatic



ISO 9002 - 1994

Davis Controls
LIMITED

TEL (905) 829-2000
FAX (905) 829-2830

London, Ont. Tel/Fax (519) 541-6953

Emco
Hycal
Klinger
Mercoid
Mitsubishi
Uticor
Veeder-Root
Warrick

CANTECH

CANTECH CONTROLS

DIV. OF CANTECH CORPORATION

"Serving industry with dependable measurement and control equipment"

Sarnia Office

Phone - (519) 332-6162

Fax - (519) 332-3944

ANDERSON GREENWOOD - Instrument Manifolds, Gauge & Hand Valves, Metal/Soft Seated Spring Loaded & Pilot Operated Relief Valves, Rupture Disks

CANTECH SYSTEMS - Heat Tracing Controllers

CEMCO - Level Controls, Check Valves, Dump Valves, Throttling Valves

CHECKPOINT SYSTEMS - Chemical Injection Pumps

CUTLER-HAMMER - PB's, Starters, Contractors, VFD's, MCC's, Photo. & Prox. Sensors, PLC's
Electrical Distribution Products

CUTLER-HAMMER IDT - Man Machine Interfaces and Industrial Computers

DEVAR - Signal Conditioners, Transmitters, Indicators

DWYER - Gauges, Level, Pressure, Temperature & Flow Instruments, Valves

F.W. MURPHY - Level, Vibration, Temperature & Pressure Switch Gauges

G.H. FLOW - Turbine Flow Meters

GULF VALVE - Wafer Check Valves

INTEMPCO - Temperature Sensors, Transmitters, Thermowells

KEYSTONE - Ball Valves and Actuators

MICON - Compressor Control Systems

NEOTRONICS - Confined Spaced Monitors

OGONTZ - Temperature Control Valves, Steam Traps

OLDHAM - Portable & Fixed Gas Monitors, Laser Opacimeters

PENNY & GILES - Paperless Chart Recorders

RAYCHEM / CHEMELEX - Electrical Heat Tracing, Tracetek Leak Detection Systems, Monitoring Systems

REOTEMP - Bimetal Thermometers, Temperature Gauges

SCIENTIFIC LININGS & COATINGS - Weather Caps for Relief Valves

SKINNER - Solenoid Valves

STRAHMAN - Drain & Sampling Valves, Stem Water Mixing Systems

WOOD - Flow, Level & Pressure Transmitters

*Cantech also provides Service, Repair & Rental for our Relief Valves,
Gas Monitors and Video Control Panel.*

2 for 1 anyone?

Problem : You have one line to carry two 4-20mA signals, installing a new line is a hassle.

Solution : Key 90A/92A two channels/one line transmitter/receiver.

From: TechNorth Canada, PO Box 1082, Sarnia N7T 7K2
Tel. 541 1720 Fax. 541 1721 E-Mail : flk@mail.cwconnect.ca

Multi-function wiring devices save space, install faster, service easier.

Multi-function wiring devices from Phoenix Contact are designed to be a compact and cost efficient means of packaging many functions in today's space-efficient control systems — each function is packaged in only 1/4 inch (6.2 mm) width.

These DIN-rail mounted, modular blocks feature dead-front construction and captive screw-clamp termination for safe, reliable installation — in a snap. Phoenix Contact has the broadest line of multi-function wiring devices and feed-thru terminal blocks in the industry.

The grouping at right is only a sampling of the many application solutions available.

For application assistance, or a copy of our newest catalogue, call or fax.

PHOENIX CONTACT LTD.
235 Watline Ave.
Mississauga, Ontario L4Z 1P3
Phone: (905) 890-2820
Fax: (905) 890-0180

1-800-890-2820



SMD technology allows relay isolation and contact ratings up to 3A in a terminal block only 1/4 inch (6.2 mm) wide.

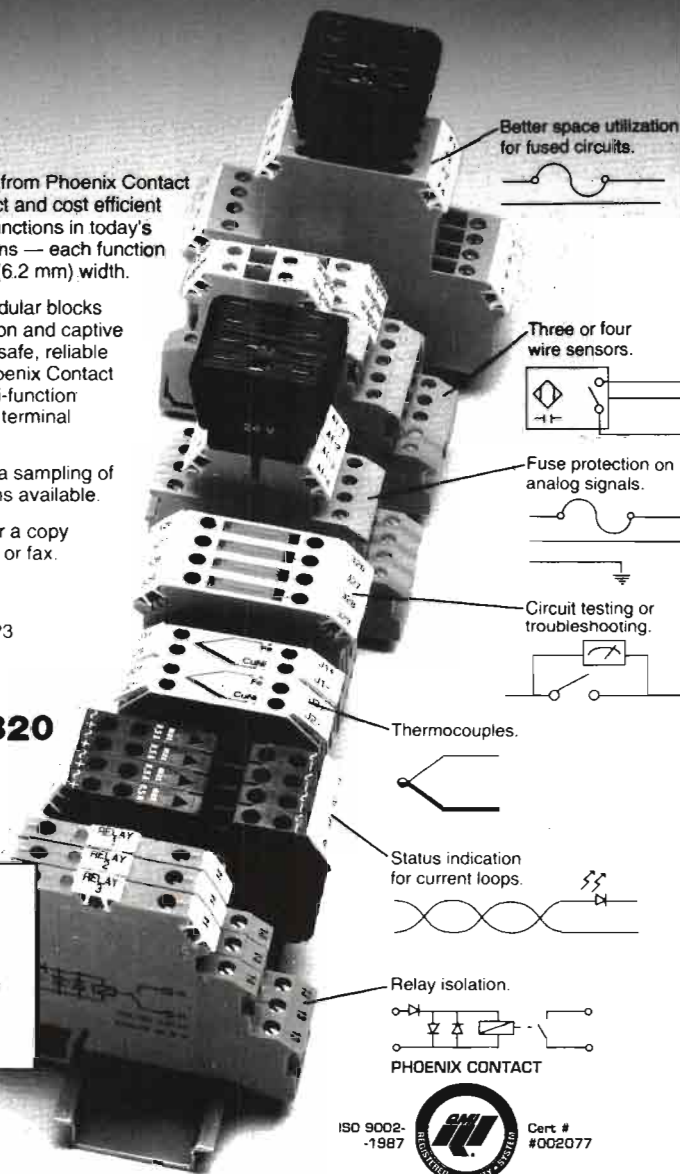

Better space utilization for fused circuits.



Three or four wire sensors.

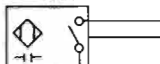

Fuse protection on analog signals.

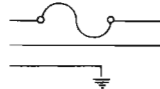

Circuit testing or troubleshooting.



Thermocouples.



Status indication for current loops.



Relay isolation.

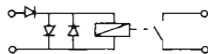

PHOENIX CONTACT

ISO 9002-1987



Cert # 002077

MISSISSAUGA, ONTARIO





Axiom Technologies Limited

LONDON
CHATHAM
WINDSOR

Tel: (519) 351-2621
Fax: (519) 351-0117
Toll-Free: 1(800) 872-8018

OMRON.

Timers, Counters, Relays, Intelligent Panel Meters, Process Controllers, PLC's, Temperature Controllers, Proximity Sensors, Photoelectrics, Laser Measurement Systems, Ultrasonic Sensors, Operator Interface Terminals.

PHENIX CONTACT

Trabtech Surge Protection, Signal Conditioners, Power Supplies, High Density Terminal Blocks, Custom Interface Modules, Electronic Modules, Varioface Interface Modules.

Klockner MOELLER





Power Distribution and Motor Control Components.

INDUSTRIAL PROJECTS LTD.

204-7100 Woodbine Ave.
Markham, ON L3R 5J2

Tel: (905) 477-0017 Fax: (905) 477-1495

Representing...

-  Conant Controls Inc.
- Selector Valves
 - Venting Valves
 - Slack Valves
 - Electric & Pneumatic Operators
 - Specials. Name Plates
-  THE ELECTRON MACHINE CORPORATION
- In-line Refractometers
 - Black Liquor Analyzers
 - Stock Consistency Transmitters
 - Wire Gauges
 - Beverage Analysis System
-  INTERNATIONAL SENSOR TECHNOLOGY
- Toxic and Combustible Gas Monitors
-  **RONAN**
- Annunciators, Temperature and Vibration Monitors, Two and Four Wire Transmitters, Lamp Cabinets, Graphic Displays, Mption Detection, Leak Detection, Intrinsically Safe Barriers, Calibrators, Sequence of Events, Recorder, Current to Pressure Transducers, P to I Convertors, Smart/Programmable 2 Wire Transmitters, Signal Conditioners, Isolators, Nuclear Measurement - Density, Level, Mass Flow and Weight
-  **SUP**
- Pressure, Differential Pressure and Temperature Switches
 - Pressure and Temperature Transmitters
 - Smart/Hart Pressure, Differential Pressure, Flow, Gauge and Level Transmitters
 - Float, Displacer, RF Probe and Ultra Sonic Level Switches (Point and Multi Point), Flow Switches
-  KING INSTRUMENT COMPANY
- Flow Meters, Rotometers
-  TORBAR FLOWMETERS LTD.
- Pitot Tube Multiport Flow Meters



1401 Meyerside Drive, Unit A
Mississauga, Ontario
L5T 1G8

tel: (905) 564-3344
fax: (905) 564-3577
e-mail: info@imo.ca



Level Switches

Gems Sensors offers CSA approved level switches, in both Single and Multi-Float configurations. Available in Stainless Steel, CPVC, Brass, Buna N., Polypropylene, Teflon, and Polysulfone materials. A wide variety of mounting and electrical configurations are also available.

SureSite

Gems Sensors offers CRN / ASME B31.1 or B31.3 approved Visual Magnetic Level Indicators. Pressures to 2650 psig (183 Bar), Temperatures to 750 degrees F (399 degrees C). Available in Stainless Steel, PVC, CPVC, Polypropylene, PVDF, Hastelloy, or other exotic materials. Electronic Controls via CSA approved Switch Modules and / or Transmitters, rated for both Hazardous or non-Hazardous locations.

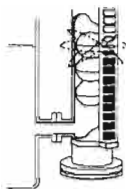

Flow Switches

Gems Sensors offers CSA approved flow switches, ideal for Nitrogen purge gas seal applications. Available in a wide variety of flow settings from 50 cc/min. to 100 gpm. Available in Stainless Steel, Rytan, Bronze, and Polypropylene. Rated CSA approved for both Hazardous and Non-Hazardous locations.

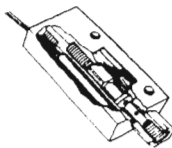

NOSHOK

Noshok offers gauges with accuracy's to ANSI 1A & 2A. Pressure ranges from Vacuum to 30,000 psi. 1-1/2" to 6" diameter dial faces. Available in ABS, Bronze, Stainless Steel, and Phenolic Case materials. NOSHOK will warrant, for "THREE YEARS", all 300, 500, 600, and 700 series liquid filled pressure gauges. Call and ask for a catalogue which details all the Gauge, Diaphragm, Bi-Metal Thermometers, and Needle Valves available.



ALPHA Controls and Instrumentation
your partner in solving your
measurement and control problems.

- ★ SALES
- ★ SERVICE
- ★ CALIBRATION
- ★ REPAIRS

- ◆ Calibration & Measuring Instruments
- ◆ Controllers & Recorders
- ◆ Dataloggers
- ◆ Digital Process Meters
- ◆ Flowmeters
- ◆ Air Quality Instruments
- ◆ Humidity Instruments
- ◆ Intrinsic Safety Products
- ◆ Level Instruments
- ◆ Pressure Products
- ◆ Signal Conditioners
- ◆ Temperature Sensors & Transmitters

ALPHA

CONTROLS AND INSTRUMENTATION

361 Steelcase Road West, Units 5 & 6
Markham, Ontario L3R 3V8

Tel: (905) 477-2133
Fax: (905) 477-4219
Toll Free: (800) 567-8686

FLOVAL

EQUIPMENT LTD.

SARNIA OFFICE

**THE SOURCE FOR
ALL YOUR FLOW
REQUIREMENTS**

MR. JOHN A. SCHNURR
251 N. VIDAL STREET
SARNIA, ONTARIO
N7T 5Y5
TEL: (519) 383-1225
FAX: (905) 669-4905

New ISA members
have a lot to offer.



Make a point of introducing
yourself at the next meeting.

WESCO
the extra
effort people

DISTRIBUTION



**FUJI
ELECTRIC**



**FCX PRESSURE
TRANSMITTERS**

- ▶ COMPACT SIZE
- ▶ ULTRA LOW POWER CONSUMPTION
- ▶ HIGH ACCURACY TO $\pm 0.075\%$
- ▶ PROPRIETARY ACIC PROMOTES LONG LIFE, HIGH RELIABILITY, AND MORE FUNCTIONALITY IN A COMPACT SIZE

SEND BROCHURE

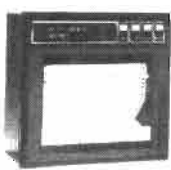

**FCR MICROJET
RECORDERS**

- ▶ LEADING-EDGE INKJET PRINTING HEAD TECHNOLOGY
- ▶ CONTINUOUS PRINTING-NOT DOT MATRIX-FOR CLEAR LEGIBLE TRACES
- ▶ FULL OFFSET FEATURE
- ▶ 100 & 180 mm MODELS :3, 6, 12, & 24 POINT
- ▶ SMALL LIGHTWEIGHT PACKAGING DESIGN

SEND BROCHURE



**FLC/FLD ULTRASONIC
FLOWMETERS**

- ▶ WIDE RANGE TURNDOWN .3 TO 32 M/SEC
- ▶ FLUID TEMPERATURE FROM -40°C TO 200°C
- ▶ UNIQUE, HIGH IMMUNITY TO ENTRAINED GASES
- ▶ OPTIONAL GRAPHIC PRINTER. OR SEND DATA TO ANY PC, PLC HOST COMPUTER

SEND BROCHURE



IOTRO

- ▶ UP TO 1
- ▶ LO & UL
- ▶ VALVE R
- ▶ TWIST L
- ▶ SATURAT
- ▶ SULPHID
- ▶ RESISTA

SEND I



**PYRO
TEMP**

- ▶ THERMC
- ▶ PROTECT
- ▶ MgO ELE
- ▶ RTD ELE
- ▶ THERMC
- ▶ SPECIAL

SEND I

RAYTEC PRODUCTS

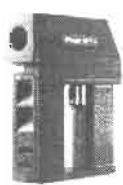

**RAYTE
TEMP**

- ▶ INTEGRA
- ▶ MONITO
- ▶ LINE SC
- ▶ 250 PD
- ▶ PORTAB
- ▶ THERMI

SEND I

PRICING & TECHNICAL SUPPORT
TEL 1-800-547-4443
FAX 1-800-552-3339

FOR VI&C PRODUCTS

YOUR SINGLE SOURCE FOR COST

WESCO

INDUSTRIAL CONTROL PRODUCTS

ON pH SENSORS

10 TIMES LONGER SERVICE LIFE
 HIGH TEMP SERVICES
 EXTRACTABLE, SELF CLEANING
 FOOD & SANITARY MODELS
 TESTED SODIUM, FLUORIDE,
 SEWAGE & ULTRA PURE WATER
 CONTACT

SEE BROCHURE

TEMPERATURE SENSORS

COUPLE ELEMENTS,
 PROTECTION TUBES, ASSEMBLIES
 ELEMENTS SHEATHS & ASSEMBLIES
 ELEMENTS, SHEATHS & ASSEMBLIES
 PROTECTION TUBES
 PURPOSE SENSORS

SEE BROCHURE

HIK NON-CONTACT TEMPERATURE SENSORS

INSTALLED FIXED SENSORS TO 2000°C
 RING SYSTEMS TO 3000°C
 MOUNTING
 RESPONSES 20 SEC./SCAN
 SINGLE NON CONTACT
 TEMPERATURE METERS

SEE BROCHURE

ELASTOFLEX PRESSURE SENSORS

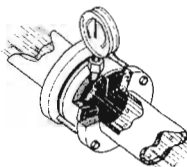

- ▶ FULL PORT NON-CLOG DESIGN
- ▶ ABRASION RESISTANT ELASTOMERIC LINER
- ▶ MULTIPLE INSTRUMENT FUNCTIONALITY
- ▶ ACCURATE & RELIABLE MEASUREMENT OF VISCOUS FLUIDS & SLURRIES
- ▶ IDEAL DRY-RUN PUMP PROTECTION

SEND BROCHURE

TURBO MAGNETIC FLOW METERS

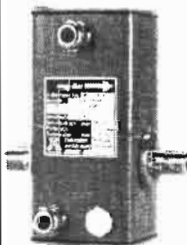

- ▶ CERAMIC (ZrO₂) FLOW TUBE
- ▶ SIZES FROM 2MM TO 12MM
- ▶ RANGES FROM 0-3 l/hr TO 0-5 m³/hr
- ▶ SEAL-LESS PLATINUM SINTER FUSED ELECTRODES
- ▶ MINIMUM LIQUID CONDUCTIVITY 0.1 uS/cm

SEND BROCHURE

TRIAC CONTROLS



- ▶ RACK & PINION, DOUBLE ACTING & SPRING RETURN ACTUATORS
- ▶ TORQUES UP TO 16 000 IN LBS
- ▶ MOUNTING DIMENSIONS TO ISO 5211
- ▶ CORROSION RESISTANT HARD ANODIZED FINISH

SEND BROCHURE

Fax

FOR FREE BROCHURE
 ✓ THE BOX FILL IN HERE
 Name _____
 Company _____
 Address _____
 Tel _____
 FAX 1-800-552-3339

EFFECTIVE CONTROL SOLUTIONS

Controls

CONTROL VALVES AND INSTRUMENTATION

REPRESENTING

VALTEK 
CONTROLS LTD.

DANIEL
INDUSTRIES CANADA

Greyline
instruments inc.

 **CELTEK**
ELECTRONICS INC

AMOT
CONTROLS

 **Bebco Industries**
Enclosure Protection Systems Division

 **A**ppalachian Controls
Environmental
..... WORLD LEADER IN TANK BLANKETING

 **TRANSMATION inc.**

Kämmer
Valves

 **ATLANTIC GROUP INC.**
Specialty Valves and Process Equipment

SARNIA OFFICE

5-1029 SALISBURY STREET
SARNIA, ONTARIO N7S 4N8

Phone: (519) 541-1973

Toll Free: (800) 268-9094

FAX: (905) 624-1878

MISSISSAUGA OFFICE

12-5160 EXPLORER DRIVE
MISSISSAUGA, ONT. L4W 4T7

Phone: (905) 624-2275

Toll Free: (800) 268-9094

FAX: (905) 624-1878



ZIRCO LTD

Calgary, Toronto, Sarnia

TOLL FREE: 1-800-461-3120

- Detonation Flame Arrestors • Vapour Tight Thief Hatches • Vent Valves • Emergency Pressure Relief vents • Complete line of Flame Arrested Burners
- Conservation Pipe-away Vents

ENARDO

- Oil / Water Interface Detectors • Ground Water Monitor • Net Oil Meters • Multi Phase Flow Meters

AGAR

- Tank Blanketing Valves
- Tank De-Pad Valves

VALVE CONCEPTS

- Pressure Relief Valves
- Emergency Shut-down valves

RUPTURE PIN TECHNOLOGY

- Petroleum Analyzers
- PPM Monitors

WEDGEWOOD TECHNOLOGY

- Emergency Shut-in Safety Valves

KING VALVES

- Sealed Tank Gauging • ARUs Temperature Controllers • High Level Shutdowns
- Tank Flanges

ZIRCO



SPEC (Sarnia) Limited

Specialty Process & Environmental Company

1550 Confederation Street, Sarnia, Ontario N7W 1A3
Tel: (519) 336-2405 • Fax: (519) 336-1177



*The Intelligent
Automation People*

KLINGER
LEVEL GAUGES



*Responsive Supplier
Since 1987*

- Level and flow measurement
- Relief disc and vents
- Heat tracing expertise
- Environmental products
- Local inventory and EDi processing of orders



- Line Blinds
- Check Valves
- Rupture Discs



Liquid Controls
Corporation
Absolute Accountability

MICRO WIRE PRODUCTS

(1980) LIMITED



THERMON

The Heat Tracing Specialists



Can-Ross Environmental Services Ltd.

**CAN-ROSS
ENVIRONMENTAL
PRODUCTS**



CYBER SYSTEMS INC.

TEL. 905-792-6677 FAX. 905-792-7742

PRODUCT LIST

- MTL • Intrinsically Safe Barriers
- A.H. Emery • Hydraulic Load Cell Weighing Systems
- Fuller • Electronic and Pneumatic Liquid Filling Systems
- Hillcraft • IS Earth Proving Unit • for tanker trucks etc.
- RGS • Intrinsically Safe Valves
- Larad • Unique, Full-bore Valves and Instrument Isolators
- Expo Safety Systems: Purging and Pressurisation

For Div 1 and Div 2, the Mini-X and Mini-Z -Purge Systems are fully pneumatic in operation, and conform to North American Standards, NFPA 496-1993. They are acceptable to Ontario Hydro, for installation in Ontario.

TYPICAL APPLICATIONS

Computer Monitors & Terminals
Programmable Controllers.
19" Rack Apparatus.
Panels & Switchgear.

Chart & Data Recorders.
Gas Analysers.
Motor Control Centers.
Condition & Monitoring.

SENTRY...

*The only name you need to know for
Sample Conditioning Equipment.*

- Sampling and analysis systems for fossil, nuclear and co-gen plants.
- Pre-engineered single point sampling stations.
- World's largest supplier of sample coolers.
- Unique rod in tube pressure reduction devices.
- Packaged cooling water systems.
- Precise temperature control units.
- Spiral Tube Heat Exchangers.



Sentry Equipment Corp.

Phone: 414-567-7256

Fax: 414-567-4523



Fryston Canada Incorporated

7370 Bramalea Road, Suite #30

Mississauga, ON L5S 1N6

Phone: 905-612-0566 or 1-800-387-7503

Fax: 905-612-0575

Complete Water Quality Monitoring Systems

From alkalinity to zinc —

*Hach's direct-reading instruments,
single-dose reagents, clear
instructions, and proven methods
make water testing convenient.*

- **Test Kits**. Over 200 single- and multiple-parameter water testing kits
- **Portable and Laboratory Instruments**. Reliable colorimetric, pH, ISE, and turbidimetric instruments that provide accurate results
- **Process Systems**. Complete on-line systems to monitor turbidity, pH, chloride, hardness, silica and more

HACH

Fryston Canada Inc.

7370 Bramalea Road
Suite 30

Mississauga, ON L5S 1N6

Telephone: 905-612-0566

Fax: 905-612-0575

Fieldbus Today... Resources on the Web

The Web links listed in this article are posted on my Fieldbus web page at:

<<http://www2.ebtech.net/~bsmith/fieldbus.htm>>

which is also listed on my home page at:

<<http://www2.ebtech.net/~bsmith/>>

Fieldbus seems to be a hot topic again. Recent articles in a number of magazines and on websites, point to a new chapter of the Fieldbus saga. The current chapter could be called Finalizing the Foundation Fieldbus Standard. Once the standard is completely approved it will allow products to be sold that conform to the long awaited standard. The next chapter could be called First Generation Foundation Fieldbus Products for Sale. Finally, we will be able to look closely at actual products. The March 1997 issue of InTech included an article called "Standardized File Exchange Eases Fieldbus Interpretability Design".

The April issue of Control magazine included an article titled "Fieldbus Reaching the Promised Lan". With the release of conformance and interpretability test kits, Foundation Fieldbus is one step closer to putting products in users' waiting hands.

An article at the Fisher Controls website called "Understanding Fieldbus" states: "One of the most anticipated changes in the process industry has been the introduction of fieldbus. Ten years in development, fieldbus has been long awaited by many process control industry users. In March 1996, the Fieldbus Foundation will release the low speed (H1) fieldbus technology. With this release, a fully functional fieldbus will be defined."

"Putting Fieldbus to Work" is another article from the Fisher Controls website that tells about the world's first commercial application of products conforming to the Fieldbus Foundation's final specification, a major Canadian chemical company's plant is using Foundation™ fieldbus-based architecture on a furnace application.

An article titled "Honeywell presents solution-centric fieldbus Approach" states it this way: "fieldbus must be more than a data pipeline. Its value lies in its ability to provide an unprecedented richness of data to the applications and services that lower product cost and improve quality. To that end, Honeywell has taken a "solution-centric" approach to the implementation of fieldbus, rather than merely a "field-centric" approach."

Fieldbus Foundation or FOUNDATION Fieldbus? "Fieldbus is coming-fast. This article explains what it is, what it will mean to you and your business and how the major international equipment suppliers are working together to ensure a single, world-wide, standard approach for interoperable measurement and control equipment."

Jim Pinto, of Action Instruments, has written "Pinto's Law of Market Confusion" As Applied to Industrial Fieldbus Networks. This article states: "For several years now, there has been a significant amount of confusion over "Fieldbus" industrial networks. Users and vendors alike have recognized the inexorable trend towards industrial networking – simplify wiring, reduce cabling costs, improved flexibility, easy system expansion or modification, increased fault-tolerance, local and remote communications ability, maintenance and operating diagnostics – the list of benefits goes on and on. And, of course, one of the major advantages is "Inter-operability" - connecting the widgets made by Vendor-A to the doo-dads made by Vendor-B, all on the same network, speaking the same language. What a wonderful world that would be...!"

The Readout Instrumentation Signpost website in Ireland has a Fieldbus page called

Catching the Bus - Towards a Standard in Digital Communications. This page has many web links including other Fieldbus sites. The Research Center for Automatic control of Nancy, in France has a Fieldbus page as does the Austrian Centre of Excellence for Fieldbus Systems. INFIDA - The Internet Fieldbus Database is another resource well worth keeping in touch with. There are also links to Bus Web pages such as: Acnet, BitBus, CAN, Open DeviceNet, CEBus, DIN-Messbus, EIB, InterBus, LonWorks, MiTS, ModBus, Profibus, SDS, ISA SP50, plus others.

PROFIBUS (PProcess FieldBUS) is the leading open fieldbus system in Europe, according to an independent study consultant, and it enjoys world-wide acceptance. If you are interested in this bus read the technical overview page.

There is a lot of Fieldbus information available in magazine articles, from the bus organizations and vendors plus the websites referenced above.

Brian Smith

Internet: bsmith@ebtech.net
 smithb@novachem.com

Home Page: www2.ebtech.net/~bsmith

ISA Magazine's on the Web

ISA Online includes an online version of the InTech Magazine. Technical articles from recent issues are available at:

WWW.isa.org/journals/intech/index.html

Industrial Computing Magazine articles are also online at:

www.isa.org/journals/ic/index.html

DIVISION NEWS

ISA Construction & Design Division

This ISA Division Mission Statement was recently updated to read:

To coordinate the activities of Constructors, Designers and Engineers in the installation of instruments and the design and installation of instrumentation and control systems. Develop Standards and Recommended Practices and establish liaison with other standards-making organizations. Promote, within the industry, the implementation and usage of Design/Construct, Construction Management, Constructability, Commissioning of Systems and Total Quality Management (TQM) techniques. To recognize the responsibility and accountability of Constructors, Designers and Engineers to users and to the general public.

Cancoppas Limited

Process Measurement - Control & Environmental Instrumentation

1045 South Service Road West, Oakville, Ontario L6L 6K3

Tel: (905) 847-2740 Fax: (905) 827-6984

Valve	PMV	<ul style="list-style-type: none"> • Pneumatic & NEMA 4X or Class 1 Div 1 EXP or I.S. • Electro-Pneumatic Positioners • Quarter & Multi Turn Pneumatic Actuators • Position Transmitters & Limit Switches
Control		
Environmental	Royce	<ul style="list-style-type: none"> • Interface Level - Total Suspended Solids Dissolved Oxygen - pH Fixed & Portable
Analytical	Epic	<ul style="list-style-type: none"> • Portable & Fixed Waste Water Sampler - Sludge Sampler
Safety	ADI	<ul style="list-style-type: none"> • Gas Sampling Pumps
	Crowcon	<ul style="list-style-type: none"> • Personal Portable & Fixed Site Gas Detection Systems
	Foxcroft	<ul style="list-style-type: none"> • Residual Chlorine - Turbidity - Chlorine Automatic Rate Control
	Regal	<ul style="list-style-type: none"> • Gas Chlorinators
Process	Sfere	<ul style="list-style-type: none"> • Universal Programmable Indicators - Transmitters - Isolators
Conditioning	CRL	<ul style="list-style-type: none"> • Universal Programmable Bar Graph Indicators - Process & Temperature Controllers
Indication		
Control	RC Systems	<ul style="list-style-type: none"> • EXP Universal Transmitter - Universal Graphic Display / Alarm
Data Acquisition	CEWE	<ul style="list-style-type: none"> • Electrical Measurement Transducers - Analogue Indicators
	Validyne	<ul style="list-style-type: none"> • P.C. Based Data Acquisition Cards Modular Signal Conditioners
	PMV	<ul style="list-style-type: none"> • Intelligent Valve Module
Measurement	Binmaster	<ul style="list-style-type: none"> • Rotary - Capacitance - Point On Demand Level Monitors
	FPP	<ul style="list-style-type: none"> • Oval Gear P.D. Flow Meters
	NICE	<ul style="list-style-type: none"> • Vortex Flow Meters
	Eldridge	<ul style="list-style-type: none"> • Thermal Dispersion Flow Meters
	KL Flow	<ul style="list-style-type: none"> • Pilot Tube - Venturi Flow Meters
	Kobold	<ul style="list-style-type: none"> • Flow - Level - Temperature - Pressure
	ICI	<ul style="list-style-type: none"> • Displacement - Incline - Acceleration
	Validyne	<ul style="list-style-type: none"> • Pressure
	Haven	<ul style="list-style-type: none"> • Process and Pressure Calibrators
Service	Cancoppas	<ul style="list-style-type: none"> • Service • Commissioning • Total Solutions - System Integration • Custom Engineering - Design

No matter what your destination in process measurement...



We're your first class ticket.

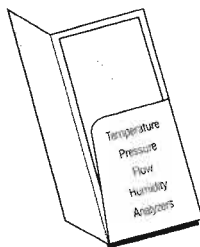

At Willer Engineering, we go beyond quality process measurement and analysis products to deliver a total package that includes:

- Engineering application assistance
- Technical product information
- Product demos
- Competitive pricing
- After sales service, support and warranty coverage

Send for our latest Product News Bulletin.



WILLER ENGINEERING LIMITED

Temperature • Pressure • Flow
• Humidity • Analyzers

Toronto

(416) 499-4421

Fax: (416) 499-0816

Montreal

(514) 333-8555

Fax: (514) 333-4662

Sarnia

(519) 336-3006
Fax: (519) 344-0607

Dartmouth

(902) 469-4400
Fax: (902) 463-1010

Sudbury

(705) 673-8900
Fax: (705) 673-8806



J & M ENGINEERING & SALES LTD.

2899 STEELES AVE., W., UNIT 4, DOWNSVIEW, ONTARIO, CANADA M3J 3A1
TEL: (416) 665-2300 FAX: (416) 665-7530

Representing the Experts in Measurement and Control

Badger Meter Inc.

Liquid Meters and Batching Control Systems. Ultrasonic Flowmeters, Open Channel and Closed Pipe, Flow Tubes & Ultrasonic Level.

Wallace & Tiernan Inc.

Flowmeters, Chlorinators, Lime Slakers, Metering Pumps, Feeders & Calibrators.

Lumenite Electronic Company

Conductivity & RF Capacitance Level Products.

Wilkerson Instrument Co., Inc.

Signal Conditioners, 2 Wire Transmitters, Indicators & Alarms.

Flowdata Inc.

Positive Displacement Flowmeters & Flow Controls for Special Applications.

L.J. Star Inc.

Visual Flow & Sight Glass Indicators

Danaher Controls

Digital Meters, Counter, Timers & Encoders.

“Where You Get Old Fashioned Service”

**New ISA Members have
a LOT TO OFFER.
BRING A FRIEND TO THE NEXT MEETING.**

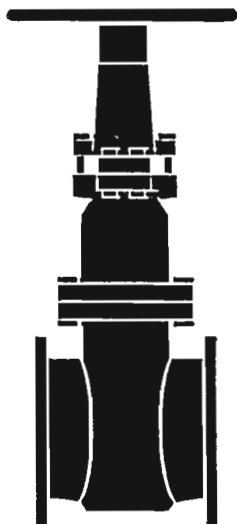

Professional Valve Service Ltd.

Quality Service For Over 25 Yrs.

859 Ontario Street, N7T 1N1
P.O. Box 761 Sarnia, Ontario N7T 7J7
Tel: (519) 336-3933 • Fax: (519) 336-6157



*– The Complete Shop and
Mobile Valve Service –*

24 HR SERVICE



			LINE PROCESS CONTROLS

5310 FINCH AVE. EAST.
UNIT #2
SCARBOROUGH, ONTARIO
M1S 5E8
PHONE: ((416) 291-8525
FAX: (416) 291-9987

SARNIA REPRESENTATIVE

**JIM ARMATAGE
TRENTEC, HARLEY**



Precision regulators, boosters and relays
I/P, P/I or E/P transducers, Explosion proof I/P transducers
Motorized regulators



BETA[®] Calibrators for RTD, t/c, mA, mV, V, pressure & frequency
Promac[®] Signal Conditioners and Wodex power transducers
Industrial annunciators



S&J/L&J[®] servo, magneto-strictive and radar tank gauging technology
L&J[®] Smart encoder/level transmitters, and Tankway systems
S&J[®] Tank vents and flame arresters



Capacitance level controls for inventory control or high level
Vibration switches
Industrial control vales & SATRs



Solenoid valves in brass, stainless steel, and plastics
Piston and diaphragm vales
Sensors for level, flow, pH, ORP and conductivity

Who do you trust for your safety control systems? ICS-Triplex, that's who!

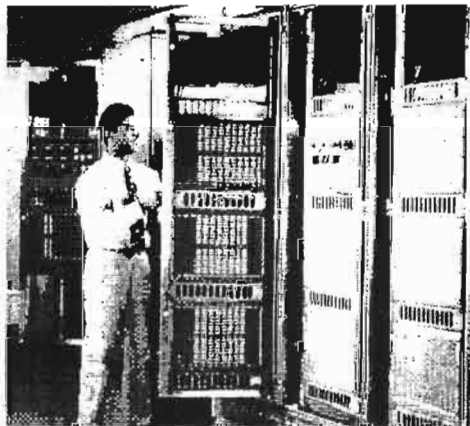

ICS-Triplex is a worldwide supplier of safety control systems with almost 30 years of experience in high risk process industries. We provide consulting services as well as turnkey design, engineering, manufacture, installation, commissioning and service of solid state, PLC and TMR technologies. Applications include shutdown systems, fire & gas systems and turbo-machinery control systems.

ICS-Triplex

16400-A Park Row
Houston, Texas 77084-5015
Phone (281) 492-0604, Fax (281) 578-3268
www.n-vision.com/ics

H C S

HEATING & CONTROL SYSTEMS



HEATERS
FOR LIQUIDS,
SOLIDS & GASES



RAMP & SOAK
PROCESS CONTROLS

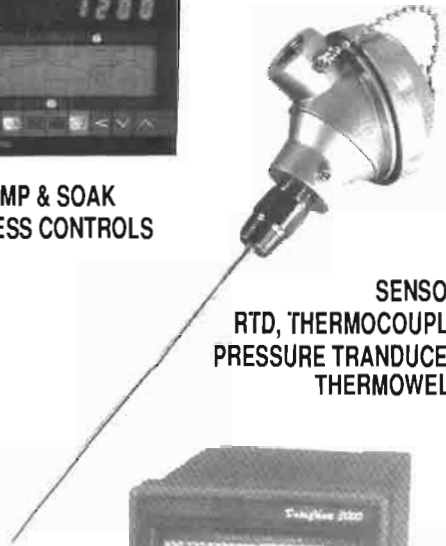

SENSORS
RTD, THERMOCOUPLES
PRESSURE TRANSDUCERS
THERMOWELLS

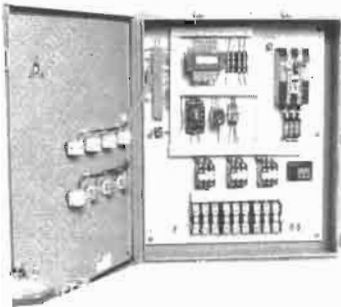

CUSTOM CONTROL PANELS



DATA ACQUISITION SYSTEMS
PAPERLESS CHART RECORDERS

1-800-279-9912



The International Society
for Measurement and Control

GROUP INTERNET RATES

Our group account is \$10/month for 10 hours. (3 month contract = \$32.10 incl. GST). Extra hours cost \$1.00/hour. ISA new user setup fee is \$10. If you use more than 20 hours per month I would recommend switching to the normal 3 month contract, which costs \$75.00 including GST for 50 hours / month. Electro-Byte is offering free classes for New Users, Intermediate Users, Search Engines, Chat Programs and E-mail Programs.

The Sarnia Section Home Page can be found at:
<http://www2.ebtech.net/~bsmith/isasarni.html>

SARNIA SECTION BBS UPDATE

As of June 15th the BBS has received 1700 calls. There have been 640 messages in the Main Board conference, 1394 downloads and 38 uploads. There have been three new callers since the last report. There are also copies of other popular Internet programs plus copies of Instrument Sizing and selection programs. The BBS phone number is (519) 541-0427.

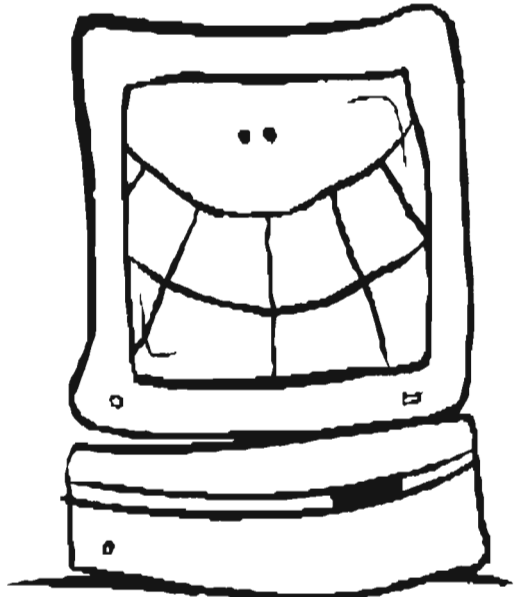

NEWS RELEASE

VALTEK

Valtek Controls & Valtek International are pleased to announce that Matheson Valve & Fittings Ltd. (MVF) has been named as the Valtek and Kammer representative for the sales territory in Southern Ontario replacing Controls Equipment (Mississauga) Ltd. This change is effective May 1, 1997.

Matheson Valves & Fittings Ltd., an ISO 9003 Registered company, has already demonstrated a commitment to a superior level of customer service to our customers for Valtek and Kammer products from their Montreal operation and is determined to service Southern Ontario customers with exceptional support.

Matheson Valves & Fittings Ltd. has offices located in Sarnia, Oakville, Ottawa and Montreal.

Your Valtek and Kammer area representative can be contacted at:

Matheson Valves & Fittings

2-1200 London Road, Suite 242, Sarnia, Ontario N7S 1P4

Tel: (519) 541-2360 Fax: (519) 541-2364

MATHESON VALVES & FITTINGS LTD.

We are extremely pleased to announce that **Gary Coles** has joined Matheson Valves & Fittings Ltd. as **Territory Manager** of our Sarnia Sales Office. Gary is a proven technical sales professional who has worked in the Sarnia area for most of his career selling and servicing valve and instrumentation products at the chemical, petrochemical and oil refinery businesses throughout the "Chemical Valley" and Southwestern Ontario.

Please contact Gary for your *manual, automatic on/off and modulating control valve* requirements at:

Matheson Valves & Fittings

2-1200 London Road, Suite 242, Sarnia, Ontario N7S 1P4

Tel: (519) 541-2360 Fax: (519) 541-2364 Pager: (519) 333-6098

Rosemount Instruments

CALGARY, AB (May 1997) – Fisher Rosemount has issued a new brochure entitled PlantWeb. The brochure introduces the new PlantWeb field-based architecture that securely links intelligent field devices, scaleable platforms and software giving customers information, control and management capabilities needed to increase performance levels and lower costs.

For a free copy of the PlantWeb brochure, call 1-888-PLANTWEB, ext. 103, or visit us at <http://www.fisher-rosemount.com>.

The new PlantWeb™ field-based architecture from Fisher-Rosemount™ combines intelligent field devices, scaleable platforms, and modular software to provide not only process control but also integrated asset management.

MOORE PRODUCTS CO. (CANADA) INC.

Moore Products Co. (Canada) Inc. is pleased to announce that Summit Controls Ltd. has been appointed the Moore Products and Krohne representative for these products in Southern Ontario. Summit Controls has offices in Cambridge and Sarnia and can be reached at: **1355 Confederation Street, Sarnia, Ontario N7S 4T2**

Tel: (519) 337-3200 Fax: (519) 337-7068

New Advertisers

The Annunciator is pleased to announce the following new advertisers:
Line Process Controls Page 50

Rosemount Instruments Ltd

You know us for Our:

**Pressure, Temperature, Flow,
Level & Analytical Transmitters**

Discover Our:

Professional Response in Service Management



Field Service Programs

Right Start
Pre-Installation and
Installation Assistance
Continuous Care
Preventative Maintenance
Contracts
Rapid Response
On-Site Service Calls
Custom Services
Designed to
meet your needs

Depot Repair

Fixed Price Repair Agreements
Know the cost of
Warranted repairs
ahead of time
Rapid Repair
Fast economical
repair agreements
PRISM Exchange
Upgrade your primary
measurement device to
the industry's best

**For the Leader in Instrumentation
and Professional Service:**

Call: 1-800-268-1151

Customer Support Centre

Tel: 1-800-268-1151
Fax: 1-800-563-3051
Service: 1-800-654-7768

ROSEMOUNT®

**FISHER-ROSEMOUNT™
Managing The Process Better:**

R.A. KIRBY SALES INC.

- SAAB TANK CONTROL - RADAR BASED LEVEL SYSTEMS
- MTS MAGNETOSTRICTIVE LEVEL SYSTEMS
- OPTEK PPM OIL/WATER, CONCENTRATION, COLOUR & TURBIDITY PHOTOMETERS
- THERMAL MASS FLOW METERS AND PROBES
- ZIRTEK HIGH TEMPERATURE O₂ ANALYZERS

#100 - 3995 BATHURST STREET
NORTH YORK, ONTARIO M3H 5V3

TEL: 416-638-1080
FAX: 416-638-9389

SENSORS, SIGNAL CONDITIONING, DATA ACQUISITION & CALBRATORS



schaevitz

Perry & Giles

POSITION SENSORS
Designed to be Better

interface
ADVANCED FORCE MEASUREMENT

Accelerometers	Paperless Recorders
Chart Recorders	Portable Calibrators
Data Acquisition Systems	Pressure
Data Recorders	Rotary Displacement
Encoders	Signal Conditioners
Humidity	Slope/Tilt
Lasers	Strain Gauges
Linear Displacement	Temperature
Load	Torque
Panel Meters	Ultrasonics
Non-Contacting Capacitive Gauging Systems	

Lucas NovaSensor

SENSORTRONICS

Leine & Linde

SENSIT



MASSA

ADP
OPTOELECTRONICS

Digitec

For all your sensing, control, acquisition
and calibration needs . . .

Call us Today!
1-800-263-4673

KIPP & ZONEN

EU

rotronic
instrument corp

Measurement
Systems



OGDEN



Durham Instruments

Products that measure. Service that measures up.

Toronto: (905) 839-9960
FAX: (905) 839-4325

Montreal: (514) 697-7054
FAX: (514) 697-4519

Calgary: (403) 242-4844
FAX: (403) 242-4863

Ottawa: (613) 248-4200

Vancouver: (604) 662-7711



EXPERIENCE AND SOLUTIONS

AIR MONITOR CORPORATION

- combustion air flow
- drying/quenching air flow
- stack gas flow

BENKE

- distillation analyzers
- freeze, flash and cloud point analyzers
- viscosity analyzers
- NIR spectrometers

DANIEL

- BTU and process gas chromatographs

EG&G BERTHOLD

- non-contact measurement
- level, massflow, basis weight, belt weigher, ash content, sulphur & lead
- microwave moisture
- density

KATES

- flow rate controllers

MAIHAK

- gas analyzers
- thermal conductivity
- total hydrocarbon FID
- TOC
- FTIR

MDA SCIENTIFIC

- toxic substance monitoring
- trace contaminant analysis systems
- single, multipoint, personal
- chemcassette technology

METTLER TOLEDO (INGOLD)

- pH and ORP measurement systems
- dissolved oxygen
- conductivity
- turbidity

PCME

- baghouse monitoring
- particle emission/dust monitors
- opacity/scintillation
- electrodynamic technology

SIEGER

- combustible and toxic gas detection
- infra-red open path hydrocarbon gas detection
- infra-red point gas detection

SOLARTRON

- liquid and gas density
- viscosity: dynamic and kinematic
- defined shear rate viscosity

TA INSTRUMENTS INC

- thermal analysis
- rheology

WEDGEWOOD TECHNOLOGY

- turbidity & colour photometers
- solids concentration
- UV and NIR analyzers
- oil-in-water monitor

WESTECH

- sample systems
- packaged analyzer systems
- CEM's
- detonation flame arresters

WHESOE VAREC

- flame arresters
- tank appurtenances and level gauging systems
- waste gas control equipment
- waste gas burners
- leak detection

	Halifax	Montreal	Toronto	Sarnia	Calgary	Edmonton	Vancouver
Tel:	902-457-1171	514-636-8761	905-890-5265	519-383-6320	403-252-8803	403-464-4740	604-737-8358
Fax:	902-457-1731	514-631-0857	905-890-6213	519-383-6322	403-253-6803	403-467-1605	604-737-8315

e-mail: westech@istar.ca

p r e s e n t s



TELEDYNE FLUID SYSTEMS

Farris Engineering

TEL: (519) 332-0141

**SIZE MASTER
PLUS III
INDUSTRY'S MOST
EFFICIENT SIZING
AND SELECTION
PROGRAM**

SPS (519) 336-8820
*Albre*FORM

INSTRUMENT ENCLOSURES & HEATERS

- SINGLE AND MULTIPLE TRANSMITTER INSTALLATIONS
- CUSTOM ANALYZER ENCLOSURES
- CUSTOM SAMPLE SYSTEM ENCLOSURES
- MODULAR INSTRUMENT HOUSINGS
- "SMART" TRANSMITTER ENCLOSURE
- COMPUTER HEAT CALCULATIONS
- CAD LAYOUT OF INSTRUMENTS
- RETROFIT FIELD REPLACEMENTS
- 100% CANADIAN (SARNIA) MANUFACTURED

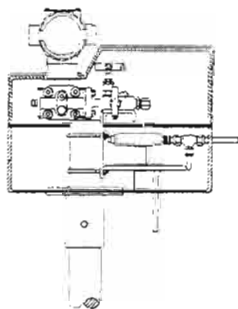

distributed by:



Sarnia Piping Specialties Ltd.

765 EVETT STREET, P.O. BOX 2018
SARNIA, ONTARIO N7T 7L1
(519) 336-8820 FAX: (519) 336-2033



Summit Controls Ltd.

Control Valves

- Neles-Jamesbury
- Badger Meter
- Sinclair Collins

Specialty Control Valves, Steam Conditionig & De-superheaters

- BTG

Ball & High Performance Butterfly Valves

- Neles-Jamesbury

Custom Designed Slide Gate Valves & Dampers

- Deltavalve

Plastic Valves & Filters

- Hayward

Valve Accessories

- Neles-Jamesbury
- StoneL
- Burkert

Control Loop Diagnostics

- Neles-Jamesbury
- Expertune

Sanitary Valves

- Flow-Tek

Flow & Level Sensors

- Burkert

Signal Conditioning

- Action

Services

- Valve Automation Centre
- Installation & Repair

1-48 Queen St. E., Cambridge NC3 2A8 • Tel: (519) 651-2730
1355 Confederation St., Sarnia N7S 4T2 • Tel: (519) 337-3200
salesinfo@summitcontrols.com
<http://www.summitcontrols.com>

CASHCO

- PRESSURE REGULATORS
 - Reducing & Back Pressure / Relief
- CONTROL VALVES - Rotary & Linear
- MANUAL LOADERS and AIRSETS

WIKA

- PRESSURE GAUGES - Test, Etc.
- CHEMICAL SEALS
- PRESSURE TRANSMITTERS / TRANSDUCERS

TELEDYNE FARRIS

- SAFETY & RELIEF VALVES
- TANK VENTING
- TEST BENCHES

APICAL

- CHARTS
 - Recording Chart Paper
 - Inking Supplies

TREND

- THERMOMETERS - Bi-metal Gas Actuated

MAGNETROL

- LEVEL CONTROLS - R.F. Capacitance, Ultrasonic & Buoyancy
 - Magnetic Level Indicator
 - Microwave
 - Thermal Dispersion
- FLOW CONTROLS - Vane, Piston Actuated Valve & Thermal Dispersion

PRIBUSIN

- SIGNAL CONDITIONERS
- ALARM UNITS - Indicating

THERMO-KINETICS

- TEMPERATURE - Measurement & Control
- SENSORS - Thermocouples, RTD's, Infrared Thermometers
- THERMOWELLS & PROTECTION TUBES
 - All sizes
- GAYESCO - Refracto-Pads & Flex-O Multicouples

M.T.L.

- INTRINSIC SAFE BARRIERS & INDICATORS



PROVINCIAL CONTROLS

DIVISION OF 660567 ONTARIO LIMITED

P.O. BOX 2946
373 VIDAL ST. S., SARNIA, ONT. N7T 7W2

TELEPHONE: (519) 336-7301
FAX: (519) 336-8082

NUMATICS

- FILTER/REGULATOR/LUBRICATOR
- SOLENOID VALVES - General Purpose, Hazardous, Intrinsically Safe
- AIR CYLINDERS - NFPA, Small Bore, Compact
- ENERTROL - Linear Decelerators, Shock Absorbers
- AIR LOGIC CONTROL
- PANELS - Pneumatic, Electrical & Electronic
- AIR DRYERS - Refrigerated & Regenerative

ERNST

- FLOW AND LEVEL INDICATORS
- SIGHT GLASSES - Glass & Gaskets
- FLOW METERS
- SIGHT FLOW INDICATORS
- EJECTORS & EDUCTORS

ORANGE RESEARCH

- DIFFERENTIAL PRESSURE & FLOW GAUGES

PERMACAL

- PRESSURE GAUGES - Direct Drive
 - Test & Process

CONANT

- SELECTOR VALVES

HANSEN

- QUICK CONNECTS - Pneumatic & Hydraulic

IMPERIAL EASTMAN

- TUBE FITTINGS - Accessories

KINETROL

- ACTUATORS, BRACKETS

P.G.I.

- VALVES & MANIFOLDS

PROVINCIAL INSTRUMENT ENCLOSURES

- FIBERGLASS INSULATED

VORTEC

- VORTEX COOLERS - Pneumatic Transfer / Handling Equipment

DWYER

- DP GAUGES
- SWITCHES
- FLOW METERS

Thermowells & Protection Tubes

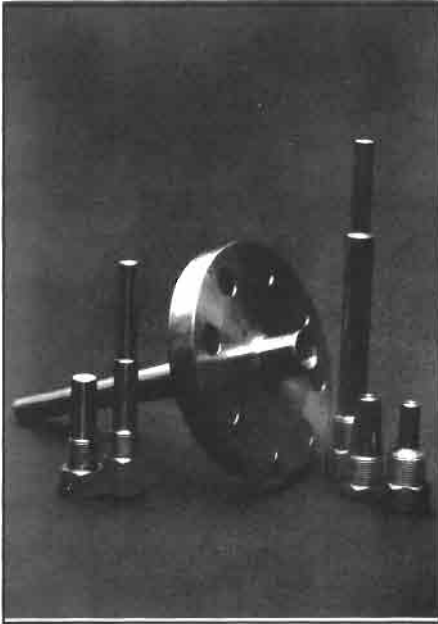

Above shows a small range and type of thermowells

No matter how large or small, one off, rush, exotics material, project or stock, call or fax for courteous prompt attention

Our thermowells are manufactured to accept standard or custom made thermometers, thermocouples, bulbs and RTD's.

Attributes:

- ▼ Solid bore up to 50" long
- ▼ CNC machined, polished finish to assure maximum corrosion resistance.
- ▼ Wide selection threaded, flanged, socket weld, heavy duty tapered for steam lines, vanstone, multicouple units
- ▼ Custom made specials in 24 hours
- ▼ Competitive prices and large in house stock of wells and material

Specifications:

- ▼ Velocity checks upon request to the power test code
- ▼ Manufactured in accordance with ASME, ASTM, ANSI and P.T.C.
- ▼ Canadian registration number
- ▼ Materials A350/LF2 A105 Carbon Steel, 316/L, 304/L, Monel, Alloy 20, Inconel, 446SS, 310SS, 347, 2205, Hastalloy, Titanium, Tantalum Oversheaths
- ▼ ISO 9002 Certified

MAC-WELD

1324 Lougar Avenue,
Sarnia, Ontario
N7S 5N7
1-800-563-0292
Tel: (519) 332-1388
Fax: (519) 332-3280

Distributed by: **YOUR LOCAL SALES REPRESENTATIVE**

searchpoint OPTIMA

FIVE YEAR GUARANTEE

SMALLER, LIGHTER, COST EFFECTIVE SEARCHPOINT OPTIMA TAKES A FRESH LOOK AT INFRARED FIXED POINT GAS DETECTION

The Searchpoint Optima is the result of rigorous field testing done under real-life conditions.

The result is a low cost, small, light yet robust point detector that can be retrofitted in existing gas detection systems.

Searchpoint Optima has no moving parts, is easy to maintain, and, with worldwide approvals, satisfies a vast range of applications and environmental conditions.

For the full story, call Westech today!

Westech Industrial Ltd. 1004, 1149 Vanier Road, Sarnia, Ontario N7S 3Y6 **(519) 383-6320**



WHY OPTIMA?

- Can detect a wide range of gases and vapours
- Self Compensating Optics
- Easy gas checking in any environment
- Ideal for retrofits
- Optional Interrogator for one man gas test
- 5 year guarantee



ANALYTICAL INSTRUMENTATION DRYERS PUREGAS® HEATLESS AIR DRYERS AND ADSORBERS FOR:

- | | |
|--|--|
| <input type="checkbox"/> Removing H ₂ O and CO ₂ gases | <input type="checkbox"/> Dry gas reference for moisture analyzers |
| <input type="checkbox"/> Dewpoints to -100° F. | <input type="checkbox"/> Dry box purging |
| <input type="checkbox"/> Natural gas drying | <input type="checkbox"/> Prevention of air line freeze-up |
| <input type="checkbox"/> Purging atmosphere chambers | <input type="checkbox"/> Providing dry cooling air for electronic stress testing |
| <input type="checkbox"/> Replacement of nitrogen bottles | <input type="checkbox"/> Explosion proof environments |
| <input type="checkbox"/> Purging infrared spectrophotometers | |

Available as stand alone units with oil free compressors.

For more information call 1-800-787-3547

- Also representing Nicotra SCADA and monitoring systems

canadian puregas equipment limited

P. O. Box 280, Dunnville, Ontario. N1A 2X5

Tel. 905-774 8600 Fax 905-774-6974

- Check boxes and Fax for more information

Start to Finish...Fisher Service is your control valve repair expert.



No other organization offers more expertise in control valve repair than Fisher Service Company.

Fisher Service Company can perform expert valve repairs either in-house or onsite at customer locations.

Call your local Fisher-Rosemount Sales Representative today to find out more.

FISHER SERVICE COMPANY
(519) 332-2300
581 VIDAL ST. S.
SARNIA, ON N7T 2V8



FISHER-ROSEMOUNT

BEP Bestobel

Yves Routhier
Technical Sales Representative

373 Vidal Street S.
Unit D3
Sarnia, ON N7T 2V3
Tel: (519) 336-0811
Fax: (519) 336-5808

LEVEL CONTROL

- Mobrey
- Madison
- Proximity

VALVES & ACTUATORS

- Tomoe (Butterfly)
- Ashford
- Hytork

WATER QUALITY ANALYZERS

- Zullig
- KDG Mobrey

COMBUSTION ANALYSIS

- Telegan

FLOW MEASUREMENT

- Erdco
- Mobrey
- Oilgear

STEAM TRAPS & TRAP TESTERS

- Bestobell

LEAK DETECTION

- Ion Track Instruments

TEMPERATURE SENSING

- Wahl Instruments
- Armtec Industries



Smart Choices from the Leader in Control

For effective measurement and control, choose quality devices from Honeywell's **TotalPlant®** portfolio. They'll help you:

- ✓ Increase productivity and profit
- ✓ Optimize use of raw materials
- ✓ Meet your customers' quality specifications
- ✓ Comply with environmental standards
- ✓ Enhance plant safety

Our **Smartline™** transmitters and flowmeters feature state-of-the-art microprocessor technology for accurate, reliable measurement of temperature, pressure, level and flow. They're field proven, easy to install and configure, and can be digitally integrated to the control system.

Honeywell offers **Leaderline™** controllers, programmers and recorders for almost any industrial application — from simple on-off control to feed forward, cascade and ratio control. Our line of circular and stripchart recorders includes advanced digital models with complex math and communication capabilities.

Superior product performance is built in and backed up by Honeywell's warranty program and comprehensive technical support.

For information, ordering or technical support, call:
Customer Response Centre 1-800-461-0013

Honeywell

Helping You Control Your World

Thoughts to get you through any crisis...

1. Indecision is the key to flexibility.
2. There is always one more jerk than you counted on.
3. You can't tell which way the train went by looking at its tracks.
4. There is absolutely no substitute for a genuine lack of preparation.
5. Nostalgia isn't what it used to be.
6. Sometimes too much drink isn't enough.
7. The facts, though they may be interesting, are irrelevant.
8. Someone who thinks logically provides a nice contrast to the real world.
9. Things are more like today than they ever were before.
10. Anything worth fighting for is worth fighting dirty for.
11. Everything should be made as simple as possible but no simpler.
12. Friends may come and go, but enemies accumulate.
13. I have seen the truth and it makes no sense.
14. This is probably as bad as it gets, but don't count on it.
15. All other things being equal, fat people use more soap.
16. If you can smile when things go wrong, you probably have someone in mind to blame.
17. One seventh of your life is spent on Mondays.
18. By the time you make ends meet, they move the ends.
19. Not one shred of evidence supports the notion that life is serious.
20. The more you run over a dead cat, the flatter it gets.

Join ISA Today!

Membership Form



INSTRUMENT SOCIETY OF AMERICA

This form may be used by any interested person wanting to join ISA or ISA International, including students. For assistance, contact ISA Member & Customer Services at (919) 549-8411.

Please type or use block letters. Sign and date below, in Section 3.

1

Name _____ Male Female Birthdate _____

Company Name _____ Division/Works _____

Position/Title _____

Check here if you are a full-time student and complete the following: School _____ Year of Graduation _____

Mailing Address: Home Work NOTE: Student member applicant, please list permanent home address.

Street Address/P.O. Box _____ Mail Stop _____

City _____

State/Province _____ Postal Code _____ Country _____

Telephone (include area code or country/city code) _____ FAX _____ Telex _____

Have you ever been a member of ISA? Yes No Previous years of membership _____

Assign me to the _____ section or the section closest to my home address.

Highest Educational Degree Earned High School Associate Bachelor Master Doctorate

Are you a registered professional engineer? Yes No State/Country Registered _____

From time to time we may make our mailing list available to companies whose products or services may interest you. If you do not want your name exchanged, please check this box. We will respect your wishes.

2

NOTE: Sections 2, 3, and 5 must be completed for processing.

Check your primary job function:

- A: General or Corporate Management
- B: Control Systems Engineering
- C: Design Engineering
- D: Production Engineering
- E: Plant Engineering or Maintenance
- F: Software Engineering
- G: Plant Information Systems
- H: Systems Integration
- I: Measurement, Testing, Quality, or Standards
- J: Research and Development
- K: Technical or Engineering Support
- L: Operations
- M: Purchasing or Procurement
- N: Education or Training
- O: Marketing or Sales
- P: Others: Describe _____

What is the primary end product manufactured or service performed at your company location? _____

Check here if no manufacturing is done at this location.

3

Signature _____

Date _____

5

Dues Payment Information

Please select the level of membership for which applying:

- Regular Member: \$60 US (Tax Deductible) \$ _____
 - Student Member: \$9 US (Limited Benefits) \$ _____
 - Division Membership: \$5 US each. \$ _____
 - Industrial Company Society Membership (reg. 555): \$30 \$ _____
- must be an ISA member.
- Total Amount Due \$ _____

Annual ISA dues include a subscription to **INTECH**, for which a non-deductible allocation of \$8.00 is made for regular members and \$3.50 for student members.

Note: The following are acceptable for remitting dues payment. Please indicate the method used. Make payable to Instrument Society of America in US currency only. If paying with international funds, see special note below.

- Check Money Order
 - American Express Eurocard MasterCard Visa
- Acct # _____ Exp. Date _____

Special Note Regarding Transfer of International Funds

Credit Card Payment is preferred; checks with proper MICR bank encoding must be drawn on your bank's corresponding NY or other US bank. Amount payable to ISA must include any bank or other processing charges.

- Wire Transfer — Add \$5.00 US for processing. Send to ISA Account #1126294, Central Carolina Bank, ABA053100465. Transfer must show applicant's name and address.
- UNESCO Coupons Money Order — Add \$5.00 US for processing.

Mail completed form and payment to: **Instrument Society of America**
Member & Customer Services
PO Box 3561
Durham, North Carolina 27702
USA

If paying by credit card, fax to: (919) 549-8288.

Division Enrollment — Also enroll me at \$5.00 each in the Divisions checked below. To join Divisions, you must also enroll as a regular or student member.

4

Automation & Technology Divisions

- (A) Analysis*
- (C) Robotics & Expert Systems
- (D) Computer Technology*
- (E) Open Systems Interconnection
- (H) Process Measurement & Control*
- (I) Maintenance
- (J) Test Measurement*
- (M) Automatic Control Systems*
- (N) Telemetry & Communications
- (P) Electro-optics
- (W) Management*

Industries & Sciences Divisions

- (B) Aerospace Industries*
- (F) Mining & Metals
- (G) Chemical & Petroleum Industries*
- (K) Construction and Design*
- (L) Pulp & Paper Industry*
- (O) Power Industry*
- (R) Food & Pharmaceutical Industries*
- (T) Textile Industry
- (U) Automotive & Vehicular
- (X) Water & Wastewater Industries
- (Y) Glass & Ceramics Industries
- (Z) Marketing & Sales*

* Students are entitled to one free membership each in the Automation & Technology and Industries & Sciences Divisions. Please choose and mark from the asterisked selections.

USERS DIRECTORY

This index lists manufacturers and trade-names alphabetically and enables users to determine the local representative for a particular manufacturer or product.

Manufacturer / Tradename

3 P
 3-D
 3M Circuit Tracer Kit
 A.H. Emery
 A.S.I.
 A.W. Sperry
 ACR Systems
 AD Technologies
 ADI
 AEM Systems
 AEMC
 AFE
 AFE Technologies Inc.
 APACS
 API Meters
 ARO
 ARi
 ASCO
 ASCO
 ASCO
 ASD
 Accutech
 Acromag
 Acrotech
 Action
 Action Instruments
 Action Instruments
 Action Instruments
 Advance Products Spray Shields
 Agar
 AiRanger
 Air Flow
 Air Monitor Corp.
 Aladco Nu-Check Valves
 Alltemp Sensor RTO/TC/Wells
 Alnor
 Alnor Instruments
 Altek
 Altek
 American
 Ametek
 Ametek
 Ametek - Analyzers
 Ametek Gauges
 Amiad
 Amot
 Amot Controls
 Amprobe
 Analogic
 Anderson Greenwood
 Annubar/DSC
 Apical Charts
 Apollo
 Appalachian Controls
 Armatek
 Armstrong
 Armtec Industries
 Ascoelectric
 Ashcroft
 Ashcroft
 Ashford Valve
 Astro
 Atkins
 Atlantic Group Inc.
 Atomac Ball & Check Valves

Local Sales Representative

Romatec
 Alpha Controls & Instrumentation
 Transcat
 Syber Systems Inc.
 Westburne Lytle
 Transcat
 Alpha Controls & Instrumentation
 Durham Instruments
 Cancoppas Limited
 Prosigma Analytics Inc.
 Transcat
 Axiom Technologies Ltd.
 CTH Industrial Controls
 Moore Products Co. (Canada) Inc.
 Lisle-Matrix Ltd.
 Great Lakes Industrial Controls
 Alpha Controls & Instrumentation
 Tubetech Ltd.
 WESCO
 Westburne Lytle
 Brian Controls
 Brian Controls
 Willer Engineering
 Transcat
 Summit Controls Ltd.
 CTH Industrial Controls
 Cambridge Controls
 Heaters Controls & Sensors Ltd.
 Sarnia Piping Specialties
 Zirco Ltd.
 Millitronics Limited
 Transcat
 Westech Industrial Ltd.
 Provincial Controls
 Tubetech Ltd.
 Baker Instruments Ltd.
 Transcat
 Alpha Controls & Instrumentation
 Transcat
 Axiom Technologies Ltd.
 Brian Controls
 Transcat
 Westech Industrial Ltd.
 Hardie Industrial Services Inc.
 Floval Equipment Ltd.
 Great Lakes Industrial Controls
 Controls
 Transcat
 Transcat
 Cantech Controls
 Floval Equipment Ltd.
 Provincial Controls
 Romatec
 Controls
 Armatek Controls
 Willer Engineering
 BEP Bestobell Canada Ltd.
 Floval Equipment Ltd.
 Romatec
 Transcat
 BEP Bestobell Canada Ltd.
 Prosigma Analytics Inc.
 Transcat
 Controls
 Sarnia Piping Specialties

Manufacturer / Tradename

Aurora
Autotech
Azonix
B & K
B.N.W.
BEHA
BEL
BJ Software
BLH Electronics
BOILER-GARD
BOMEM
BS & B
BTG Inc.
BTG Polymetron
Babbitt
Bacharach - Hand Held Instruments
Backos
Badger Meter
Badger Meter
Bailey
Bailey/Fischer & Porter
Baldwin Environmental Inc.
Balluff
Balston Filters
Barber-Colman
Barksdale
Barnant
Barnant
Barton
Baumann
Beacon Electronics
Beamex
Bebco Industries
Beckman Industrial
Bellofram
Benke
Bestobell Steam, Div. of Richards Ind.
Bestobell Valves
Beta
Beta
Bi-Lok Fittings
Biccotest
Biddle
Bin-Master
Binmaster
Bio-Tek
Bodenseewerk/Perkin Elmer
Bourdon-Sedeme (Manobourdon) Gauges
Brandt
Branson
Bristol Babcock
Brooklyn Thermometer
Brooks
Burkert
Burling Instruments
CEWE
CRL
CSI - Microloggers
Cajon Pipe Fittings
Cal
California Analytical
Can-Ross
Cantech Systems
Carle Chromatography
Cash-Acme
Cashco Canada
Cashco Canada, Inc.
Castell Interlocks
Cellex
Cellex
Celtek Electronics
Cemco

Local Sales Representative

Great Lakes Industrial Controls
Davis Controls
Transcat
Transcat
Floval Equipment Ltd.
Transcat
Willer Engineering
Davis Controls
CB Engineering
Lisle-Matrix Ltd.
Prosigma Analytics Inc.
Romatec
Summit Controls Ltd.
Prosigma Analytics Inc.
Industrial Technical Services
Transcat
Great Lakes Industrial Controls
J & M Engineering & Sales Ltd.
Summit Controls Ltd.
Tubetech Ltd.
Tubetech Ltd.
Novatech
Davis Controls
Sarnia Piping Specialties
Davis Controls
Tubetech Ltd.
Heaters Controls & Sensors Ltd.
Transcat
Armatek Controls
Lakeside Process Controls
R.A. Kirby Sales Inc.
Transcat
Cantrols
Transcat
Romatec
Westech Industrial Ltd.
BEP Bestobell Canada Ltd.
BEP Bestobell Canada Ltd.
Armatek Controls
Transcat
Sarnia Piping Specialties
Transcat
Transcat
Regional Process Equipment
Cancoppas Limited
Transcat
CEM Specialties Inc.
Sarnia Piping Specialties
Willer Engineering
Transcat
Sharp Valve & Instrumentation
Transcat
Great Lakes Industrial Controls
Summit Controls Ltd.
Baker Instruments Ltd.
Cancoppas Limited
Cancoppas Limited
Campbell Scientific (Canada) Corp.
Huron Valve & Fittings
Davis Controls
Brian Controls
Spec Sarnia Limited
Cantech Controls
R.A. Kirby Sales Inc.
Westburne Lytle
Provincial Controls
Cambridge Controls
Great Lakes Industrial Controls
Armatek Controls
Spec Sarnia Limited
Cantrols
Cantech Controls

Manufacturer / Tradename

Century Instrument
Century Valve
Cerabar
Chandler
Chatam Controls
Checkpoint Systems
Chemical Systems
Chemline
Chemtrol
Chemtrol
Chessel
Chessel
Clif Mock
Colder
CompuFlo III
Computer Keyboard Systems (CKS)
Con-Tek
Conant Controls Inc.
Conant Valves
Conders
ConneXt
Consolidated
Consolidated Controls
Control Instruments Corp.
Control Microsystems
Controlair
Controlair Inc.
Cooper Instruments
Cosa
Cosa
Crowcon
Crowcon Gas Detection
Custom Control Sensors
Cutler-Hammer
Cybex
DATATEST
DGH
DPL Plus
Dahl
Danaher Controls
Danfoss
Danfoss Mfg. Co. Ltd. - Denmark
Daniel Industries
Data Industrial Corporation
Data Precision
Datel
Davis Instruments
DeZurik
Defelsko
Delavan
Delphian
Delta F Corporation
Delta-M
Deltabar
Deltacon
Deltapilot
Deltavalve
Detector Electronics (Dettronics)
Devar
DewPro
Dewrance
Dianachart
Dickson
Digitec
Digitec
Dixson Inc.
Dopak
Dover Gas Technologies
Dow Plastic Lined Piping Products
Drainall
Druck
Ducon Environmental Systems

Local Sales Representative

Sarnia Piping Specialties
Brian Controls
Endress + Hauser
Transcat
Heaters Controls & Sensors Ltd.
Cantech Controls
R.A. Kirby Sales Inc.
Floval Equipment Ltd.
U & I Supply
WESCO
TubeTech Ltd.
Willer Engineering
Westburne Lytle
Davis Controls
Milltronics Limited
CB Engineering
Lakeside Process Controls
Industrial Projects Ltd.
Provincial Controls
Transcat
CTH Industrial Controls
Contro Valve Inc.
Transcat
Willer Engineering
Brian Controls
WESCO
Cambridge Controls
Transcat
Brian Controls
Industrial Technical Services
Cancoppas Limited
Regional Process Equipment
Willer Engineering
WESCO
CB Engineering
R.A. Kirby Sales Inc.
Alpha Controls & Instrumentation
Milltronics Limited
Armatek Controls
J & M Engineering & Sales Ltd.
Davis Controls
Lisle-Matrix Ltd.
Canrols
Cambridge Controls
Transcat
Transcat
Transcat
Floval Equipment Ltd.
Transcat
Armatek Controls
Romatec
Prosigma Analytics Inc.
Brian Controls
Endress + Hauser
CTH Industrial Controls
Endress + Hauser
Summit Controls Ltd.
CB Engineering
Cantech Controls
Endress + Hauser
Contro Valve Inc.
Alpha Controls & Instrumentation
Transcat
Brian Controls
Durham Instruments
CTH Industrial Controls
Westburne Lytle
Veronics
Sarnia Piping Specialties
Great Lakes Industrial Controls
Transcat
R.A. Kirby Sales Inc.

Manufacturer / Tradename

Durakool
Duro-Sense
Dwyer
Dwyer
Dwyer
Dwyer
Dwyer DP Gauges/Switches
Dylon
Dynapar
E.G. & G. Chandler
ECD
ECD
ECOM America Ltd.
EG & G Berthold
EG & G Flow Technology Inc.
EIT
EMCO
ENU
ETC
Eagle Signal
Eaton IDT
EchoMax
Echotel Ultrasonic
El-O-Matic
Elasto-Valve
Eldridge
Electromatic
Electromatic
Elremco Timers - England
Elsag Bailey
Elsag Bailey Analytical Division
Enardo
Encoder
Endress + Hauser
Enerrol Shock Absorbers
Enerrols
Engineered Valves International (E.V.I.)
Enraf Inc.
Environmental Technologies Group Inc.
Epic
Erdco
Erhard Valves - Germany
Ernst Flow & Level
Euchner
Eurotherm
Eurotron
Exergen
Exotherm
Expertune
Expo Safety Systems
F.B. Leopold - USA
F.W. Bell
F.W. Murphy
FCI
FPP
FUJI
Fairchild
Farris
Farris Relief Valves
Fieldview
Fike
Fike Canada Inc.
Fischer & Porter
Fischer & Porter
Fisher Controls
Fisher Research
Fisher Service
Fisher-Rosemount Systems
Flow Meter Co. - England
Flow Research
Flow-Tek
Flowdata Inc.

Local Sales Representative

Davis Controls
Transcat
Baker Instruments Ltd.
Cantech Controls
Davis Controls
Transcat
Provincial Controls
Great Lakes Industrial Controls
Davis Controls
R.A. Kirby Sales Inc.
Novatech
Transcat
R.A. Kirby Sales Inc.
Westech Industrial Ltd.
CB Engineering
Novatech
Davis Controls
Durham Instruments
Transcat
Davis Controls
Cantech Controls
Milltronics Limited
Provincial Controls
Westburne Lytle
WESCO
Cancoppas Limited
Davis Controls
Heaters Controls & Sensors Ltd.
Lisle-Matrix Ltd.
Tubetech Ltd.
Prosigma Analytics Inc.
Zirco Ltd.
Axiom Technologies Ltd.
Regional Process Equipment
Provincial Controls
Axiom Technologies Ltd.
Westburne Lytle
Willer Engineering
Novatech
Cancoppas Limited
BEP Bestobell Canada Ltd.
Lisle-Matrix Ltd.
Provincial Controls
Davis Controls
Heaters Controls & Sensors Ltd.
Industrial Technical Services
Heaters Controls & Sensors Ltd.
Heaters Controls & Sensors Ltd.
Summit Controls Ltd.
Syber Systems Inc.
Lisle-Matrix Ltd.
Transcat
Cantech Controls
Willer Engineering
Cancoppas Limited
Heaters Controls & Sensors Ltd.
Regional Process Equipment
Flovial Equipment Ltd.
Provincial Controls
Lakeside Process Controls
Sharp Valve & Instrumentation
Brian Controls
Elsag Bailey
TubeTech Ltd.
Lakeside Process Control
Transcat
Lakeside Process Controls
Lakeside Process Controls
Lisle-Matrix Ltd.
Flovial Equipment Ltd.
Summit Controls Ltd.
J & M Engineering & Sales Ltd.

Manufacturer / Tradename

Fluid Data/Amscor
 Fluke
 Foxboro
 Foxcroft
 Fuji
 Fuji Electric
 Fulier
 G.H. Flow
 G.W. Dahl
 GASCO
 GGOSCO Needle Valves
 GGOSCO Valves
 GO Regulators
 GO Switch (Proximity)
 GPE
 Galtek
 Gamma Silometer
 Gastech Instruments
 Gems Sensors
 General Eastern
 General Resistance
 Geokon
 George Fischer +GF+
 Global
 Graham Manufacturing
 Gralab
 Granucor
 Granuflow
 Granumet
 Graseby / STI
 Great Plains Industries
 Greyline Instruments
 H.D. Baumann
 HCS
 Hach
 Hancock
 Hansen Quik Connects
 Hardy Instruments
 Hartman-Technica
 Hartmann & Braun
 Hathaway
 Hathaway-Wodex
 Haven
 Haws
 Hayward
 Hayward
 Hedland
 Hedland Flowmeters
 Heise
 Hewlett Packard
 Hex Valve
 Hiltap Couplers
 Hiltcroft
 Hitachi - Oscilloscopes
 Hoffer Flow Controls - USA
 Honeywell
 Honeywell
 Honeywell - Recorders
 Honeywell Controllers & Recorders
 Horiba
 Houston Atlas
 Huntron
 Hy-Cal
 HydroGuard
 IBM Industrial Computers
 ICI
 IDEC
 IET
 IMS
 ISI
 ITT Barton Instruments
 ITT Conoflow Regulators & Seals

Local Sales Representative

Armatek Controls
 Transcat
 Spec Sarnia Limited
 Cancoppas Limited
 Industrial Technical Services
 WESCO
 Syber Systems Inc.
 Cantech Controls
 Armatek Controls
 Novatech
 Westburne Lytle
 Hardie Industrial Services Inc.
 Sarnia Piping Specialties
 Lakeside Process Control
 Sharp Valve & Instrumentation
 Romatec
 Endress + Hauser
 R.A. Kirby Sales Inc.
 IMO Industries
 Willer Engineering
 Transcat
 Campbell Scientific (Canada) Corp.
 Brian Controls
 Transcat
 Lakeside Process Controls
 Transcat
 Endress + Hauser
 Endress + Hauser
 Endress + Hauser
 CB Engineering
 Armatek Controls
 Cantrols
 Lakeside Process Controls
 Great Lakes Industrial Controls
 Fryston Canada Inc.
 Contro Valve Inc.
 Provincial Controls
 CTH Industrial Controls
 Transcat
 TubeTech Ltd.
 Armatek Controls
 Alpha Controls & Instrumentation
 Cancoppas Limited
 Great Lakes Industrial Controls
 CTH Industrial Controls
 Summit Controls Ltd.
 Brian Controls
 R.A. Kirby Sales Inc.
 Transcat
 Transcat
 Sharp Valve & Instrumentation
 U & I Supply
 Syber Systems Inc.
 Transcat
 Lisle-Matrix Ltd.
 Brian Controls
 Davis Controls
 Transcat
 Provincial Controls
 Alpha Controls & Instrumentation
 R.A. Kirby Sales Inc.
 Transcat
 Davis Controls
 Endress + Hauser
 CB Engineering
 Cancoppas Limited
 Axiom Technologies Ltd.
 Transcat
 Great Lakes Industrial Controls
 Heaters Controls & Sensors Ltd.
 Armatek Controls
 Sarnia Piping Specialties

Manufacturer / Tradename

ITT Engineered Valves
ITT Neo-Dyn Switches
IVO Industries - USA
Illinois Instruments
Imperial Eastman
Imperial Eastman
Imperial Eastman Fittings
Industrial Scientific
Industrial Sensors
Innovative Sensors Inc.
Inor
Intellution
Intempco
Interface
Interface
International Sensor Technology
Ion Track Instrumentation (ITI)
Ionics Instrument Division
Iotron
Ircan
Isolok
J-Tec
J.M. Canty, Inc.
J.U.M.
JB Engineering
Jacoby Tarbox
Jensen
Jerguson Level Gauges
Jofra
Johnson Yokogawa
Jordan Controls, Inc.
Julius Bauser - Germany
K-Tek
KDG Mobrey
KEP
KF Industries
KL Flow
KNF Neuberger
KTM
Kammer Control Valves
Kammer Control Valves
Kane-May
Kates
Kay Ray/Sensall
Kaye
Kaye Instruments
Keddco Mfg Ltd.
Keller
Kenmac
Kenwood USA
Ketema
Kinetrol Actuators
Kinetrol Actuators
King Instrument Company
King Valves
Kipp & Zonen
Klinger
Klinger
Kobold
Kobold
Koch
Kotron Capacitance
Krebs Engineer
Kreyenborg
Krohne
Kurz
Kurz
L & J Technologies
L.J. Star Inc.
LAGCO Flumes - USA
LC Meters
LCI-Luwa

Local Sales Representative

Romatec
Sarnia Piping Specialties
Lisle-Metrix Ltd.
Veronics
Axiom Technologies Ltd.
U & I Supply
Provincial Controls
Brian Controls
Heaters Controls & Sensors Ltd.
Prosigma Analytics Inc.
Alpha Controls & Instrumentation
CB Engineering
Cantech Controls
Durham Instruments
Willer Engineering
Industrial Projects Ltd.
BEP Bestobell Canada Ltd.
Veronics
WESCO
Willer Engineering
Great Lakes Industrial Controls
Brian Controls
Cambridge Controls
Industrial Technical Services
Transcat
Romatec
Transcat
Romatec
Transcat
CB Engineering
Cambridge Controls
Lisle-Metrix Ltd.
CB Engineering
BEP Bestobell Canada Ltd.
Brian Controls
Great Lakes Industrial Controls
Cancoppas Limited
Transcat
Regional Process Equipment
Cantrols
Westburne Lytle
Transcat
Westech Industrial Ltd.
Rosemount Instruments
Transcat
CB Engineering
U & I Supply
Campbell Scientific (Canada) Corp.
Great Lakes Industrial Controls
Transcat
Brian Controls
Hardie Industrial Services Inc.
Provincial Controls
Industrial Projects Ltd.
Zirco Ltd.
Durham Instruments
Davis Controls
Spec Sarnia Limited
Cancoppas Limited
Regional Process Equipment
Romatec
Provincial Controls
Flovial Equipment Ltd.
Great Lakes Industrial Controls
Moore Products Co. (Canada) Inc.
Brian Controls
Transcat
Sharp Valve & Instrumentation
J & M Engineering & Sales Ltd.
Lisle-Metrix Ltd.
Spec Sarnia Limited
Great Lakes Industrial Controls

Manufacturer / Tradename

LEOPOLD
LFE Instruments - USA
LI-COR
LMI
LMI
Land
Larad
Laurence
Leader
Leaderline
Lee-Dickens Ltd. - England
Legris
Leine & Linde
Lenord + Bauer
Leslie
Lewis
Limitorque
Liquid-O-Ring
Liquiphant
Logic Beach
Love
Lucas Novasensor
Lumenite Electronic Company
M & C Products
M point
M-Tek
M.T.S.
MCS
MDA Scientific
MDI
MKS
MTL
MTL Intrinsic Safe Barriers
MacWeld
Madison
Madur Electronics
Magnetrol
Magnetrol Level & Flow
Maihak
Major
Manobourdon
Marine Moisture Co.
Martel
Masoneilan
Massa
Max
McCrometer
Mead
Measurement Systems
Meeco Inc.
Mercoid
Meriam Instruments
Meriam Instrumnets
Mesa Laboratories
Met One
Metrix
Metrix Timers
Mettler Toledo
Micon
Micro Motion
Micro Wire
MicroRanger
Micronics Ltd.
Micropilot
Mid-West Instrument
Mid-West Instrument
Mihjets
Mikron
MillFlo
Milltronics
Milton Roy - Liquid Metronics Division
Milwaukee

Local Sales Representative

Lisle-Metrix Ltd.
Lisle-Metrix Ltd.
Campbell Scientific (Canada) Corp.
Novatech
U & I Supply
Transcat
Syber Systems Inc.
Great Lakes Industrial Controls
Transcat
Honeywell
Lisle-Metrix Ltd.
Axiom Technologies Ltd.
Durham Instruments
CTH Industrial Controls
Great Lakes Industrial Controls
Transcat
Sharp Valve & Instrumentation
Great Lakes Industrial Controls
Endress + Hauser
Durham Instruments
Davis Controls
Durham Instruments
J & M Engineering & Sales Ltd.
CEM Specialties Inc.
Endress + Hauser
Transcat
R.A. Kirby Sales Inc.
Heaters Controls & Sensors Ltd.
Westech Industrial Ltd.
Heaters Controls & Sensors Ltd.
Transcat
Syber Systems Inc.
Provincial Controls
Heaters Controls & Sensors Ltd.
BEP Bestobell Canada Ltd.
Novatech
Flovat Equipment Ltd.
Provincial Controls
Westech Industrial Ltd.
Alpha Controls & Instrumentation
Sarnia Piping Specialties
R.A. Kirby Sales Inc.
Transcat
Contro Valve Inc.
Durham Instruments
Willer Engineering
Brian Controls
Transcat
Durham Instruments
Novatech
Davis Controls
Transcat
Brian Controls
Brian Controls
Armatek Controls
Campbell Scientific (Canada) Corp.
Transcat
Lisle-Metrix Ltd.
Westech Industrial Ltd.
Cantech Controls
Rosemount Instruments
Spec Sarnia Limited
Milltronics Limited
Veronics
Endress + Hauser
Brian Controls
Hardie Industrial Services Inc.
Spec Sarnia Limited
Transcat
Milltronics Limited
Milltronics Limited
U & I Supply
Flovat Equipment Ltd.

Manufacturer / Tradename

Mini-X Purge Systems
Mini-Z Purge Systems
MiniRanger Plus
Mitac
Mitsubishi
Mobrey
Molecular Analytics LLC
Monarch
Monitek
Monitor Labs
Monitor Labs
Moore
Moore Industries
Moore Products Pressure Regulators
Mueller
Multi-Amp
Multi-Volt
MultiRanger Plus
Multicap
Multiglass
Mycro
Myron L
NBS
NGI
NICE
Nassau Instrument
Neles-Jamesbury
Neotronics
Neotronics
Nil-Cor
Nivocompact
Nivosonic
Norriseal Butterfly Valves
Norstat
Northern Vibrator
Noshok
Novatech Engineering Group
Numatics
Numatics Cylinders
Numatics F/R/Ls
Numatics Solenoid Valves
Nupro Valves
Nusonics
O'Brien Corporation
OCM III
OSI Semitronic
Oakton
Ogden
Ogden
Ogontz
Oilgear
Oldham
Oliver Valves
Omron
Optek
Orange Research DP Switch
Orion
PCME
PGI
PGI Valves & Manifolds
PMV
PMV
PTC
Pacer Industries
Pamark Manifolds
Panalarm
Panalarm
Panametrics PCI Division
Papailias
Parker Hannifin
Partlow
Paul Mueller

Local Sales Representative

Syber Systems Inc.
Syber Systems Inc.
Milltronics Limited
CTH Industrial Controls
Davis Controls
BEP Bestobell Canada Ltd.
Novatech
Transcat
Willer Engineering
Brian Controls
Romatec
Moore Products Co. (Canada) Inc.
Armatek Controls
Transcat
Great Lakes Industrial Controls
Transcat
Transcat
Milltronics Limited
Endress + Hauser
Great Lakes Industrial Controls
Moore Products Co. (Canada) Inc.
Transcat
Transcat
Transcat
Cancoppas Limited
Transcat
Summit Controls Ltd.
Cantech Controls
Transcat
Contro Valve Inc.
Endress + Hauser
Endress + Hauser
Sarnia Piping Specialties
Davis Controls
Flovat Equipment Ltd.
IMO Industries
Novatech
Axiom Technologies Ltd.
Provincial Controls
Provincial Controls
Provincial Controls
Huron Valve & Fittings
Armatek Controls
CB Engineering
Milltronics Limited
CTH Industrial Controls
Transcat
Durham Instruments
Heaters Controls & Sensors Ltd.
Cantech Controls
BEP Bestobell Canada Ltd.
Cantech Controls
Sarnia Piping Specialties
Axiom Technologies Ltd.
R.A. Kirby Sales Inc.
Provincial Controls
Transcat
Westech Industrial Ltd.
Regional Process Equipment
Provincial Controls
Cancoppas Limited
Regional Process Equipment
Transcat
Transcat
Provincial Controls
Cambridge Controls
Willer Engineering
Veronics
Great Lakes Industrial Controls
Tubetech Ltd.
WESCO
Great Lakes Industrial Controls

Manufacturer / Tradename

Pelican
 Penberthy
 Penberthy Instruments
 Penny & Giles
 Penny + Giles

Local Sales Representative

Transcat
 Brian Controls
 Hardie Industrial Services Inc.
 Cantech Controls
 Durham Instruments

Manufacturer / Tradename

Stonel
 Strahman
 Sugino
 Superior
 Swagelok Tube Fittings
 Syscon
 Systematix
 T.B. Woods
 TA Instruments
 TBI
 TBI-Bailey
 TBV
 TDC-3000
 TIF
 TLV
 TSI
 Tapecoat Canada
 Tate-Andale
 Taylor Hand Actuated Pressure Calibrator
 Techmation
 Techne
 Technipower
 Tegam
 Tektronix
 Tel-Tru
 Tel-Tru
 Tel-Tru Thermometers
 Teledyne Analytical
 Teledyne Combustion Efficiency Analyzer
 Teledyne-Farris Relief Valves
 Telegan
 Telematic
 Tempco
 Tenor Industrial Control
 Testo Inc.
 Testoterm
 Texas Electronics - Raingauges
 Texas Sampling
 Texas Sampling Inc.
 The Electron Machine Corporation
 The Probe
 Theben
 Thermal Instrument Co.
 Thermo Electric
 Thermo Electric - Calibrators
 Thermo-Kinetics Temperature Products
 Thermon
 Thermox
 Time Electronics
 Tomoe Valves
 Torbar Flowmeters Ltd.
 Tour & Anderson
 Tower-Gard
 Transmation
 Transmation
 Transtector Systems
 Trend B-Metal Thermometers
 Trerice
 Tricentric
 Tripp-Lite
 Tritron
 Tuffline Valve
 Turbo
 Tytronics Inc.

Local Sales Representative

Summit Controls Ltd.
 Regional Process Equipment
 Cantech Controls
 Axiom Technologies Ltd.
 Great Lakes Industrial Controls
 Huron Valve & Fittings
 Heaters Controls & Sensors Ltd.
 Willer Engineering
 Axiom Technologies Ltd.
 Westech Industrial Ltd.
 TubeTech Ltd.
 Eltag Bailey
 Romatec
 Honeywell
 Transcat
 TubeTech Ltd.
 Willer Engineering
 Sarnia Piping Specialties
 Great Lakes Industrial Controls
 Transcat
 Lakeside Process Control
 Transcat
 Transcat
 Transcat
 Transcat
 Brian Controls
 Transcat
 Hardie Industrial Services Inc.
 Armatek Controls
 Transcat
 Provincial Controls
 BEP Bestobell Canada Ltd.
 Willer Engineering
 Heaters Controls & Sensors Ltd.
 Heaters Controls & Sensors Ltd.
 Baker Instruments Ltd.
 Transcat
 Campbell Scientific (Canada) Corp.
 Great Lakes Industrial Controls
 BEP Bestobell Canada Ltd.
 Industrial Projects Ltd.
 Milltronics Limited
 Davis Controls
 R.A. Kirby Sales Inc.
 Armatek Controls
 Transcat
 Provincial Controls
 Spec Sarnia Limited
 Willer Engineering
 Transcat
 BEP Bestobell Canada Ltd.
 Industrial Projects Ltd.
 Floval Equipment Ltd.
 Lisle-Matrix Ltd.
 Cantrols
 Transcat
 Cantech Controls
 Provincial Controls
 Great Lakes Industrial Controls
 Westburne Lytle
 Transcat
 Great Lakes Industrial Controls
 Regional Process Equipment
 WESCO
 Novatech

Manufacturer / Tradename

Universal Enterprises
Unomat
Vaccon Vacuum Products
Vaisala
Vaisala - RH, Barometric Pressure
Valhalla
Validyne
Valtek Controls
Valve Concepts
Valvtech
Vector-Vid
Veeder-Root
Velan
Veriflo
Veris
Versatile Instruments
Viatran
Vista Scientific
Vitec
Viz
Vortec Coolers
Vortisand
WSA
Wabco
Wahl
Walker Scientific
Wallace & Tiernan
Wallace & Tiernan - Pressure Calibrators
Warren Jones Engineering - England
Warrick
Waterman Industries - USA
Watts
Watts
Wedgewood Technology
Weed
Weidmuller - Conditioners/Power Supplies
Weksler Instruments
Westech
Westinghouse
Westronics
Wey Valve
Whesso Varec
Whipps Inc. - USA
Whitey Valves
Whitman
Wika
Wika Chemical Seals
Wika Gauges
Wika Gauges
Wika Pressure Transmitters/Transducers
Wilkerson
Wilkerson Instrument Co. Inc.
Williams Instrument Co.
Winters
Wood's
Woodhead
Worcester
Worcester Controls
Wright-Austin
XPL Plus
Xomox
Yarway
Yokogawa Test Equipment
Zellweger Analytics
Zirtek Corporation
Zullig

Local Sales Representative

Transcat
Transcat
Provincial Controls
Transcat
Campbell Scientific (Canada) Corp.
Transcat
Cancoppas Limited
Controls
Zirco Ltd.
Regional Process Equipment
Transcat
Davis Controls
Westburne Lytle
Armatek Controls
Alpha Controls & Instrumentation
Sharp Valve & Instrumentation
Willer Engineering
Transcat
Transcat
Transcat
Provincial Controls
Great Lakes Industrial Controls
Great Lakes Industrial Controls
Great Lakes Industrial Controls
BEP Bestobell Canada Ltd.
Transcat
J & M Engineering & Sales Ltd.
Transcat
Lisle-Metrix Ltd.
Davis Controls
Lisle-Metrix Ltd.
Floval Equipment Ltd.
Great Lakes Industrial Controls
Zirco Ltd.
Cantech Controls
CTH Industrial Controls
Baker Instruments Ltd.
Westech Industrial Ltd.
WESCO
Durham Instruments
Great Lakes Industrial Controls
Westech Industrial Ltd.
Lisle-Metrix Ltd.
Huron Valve & Fittings
Davis Controls
Sharp Valve & Instrumentation
Provincial Controls
Provincial Controls
Regional Process Equipment
Provincial Controls
Transcat
J & M Engineering & Sales Ltd.
Willer Engineering
Floval Equipment Ltd.
U & I Supply
Axiom Technologies Ltd.
Floval Equipment Ltd.
U & I Supply
Great Lakes Industrial Controls
Milltronics Limited
Regional Process Equipment
Great Lakes Industrial Controls
Transcat
Prosigma Analytics Inc.
R.A. Kirby Sales Inc.
BEP Bestobell Canada Ltd.

Welding System

The State-of-the-Art System that gives you superior weld quality and increased productivity in a simple, safe design.



Welding System COMPONENTS

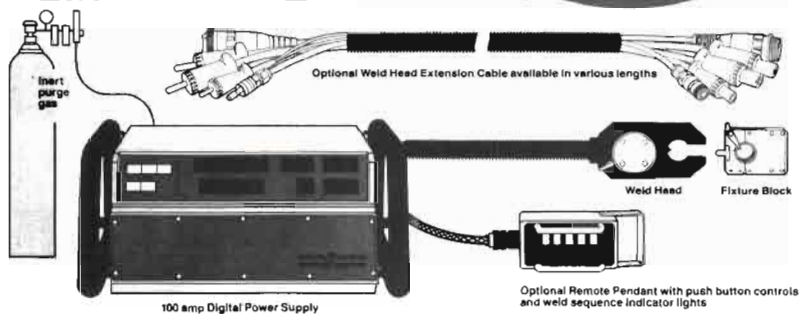

100 amp Digital Power Supply

Optional Weld Head Extension Cable available in various lengths

Weld Head

Fixture Block

Optional Remote Pendant with push button controls and weld sequence indicator lights

Weld Ended Valves & Fittings

The CAJON Welding System can be used with a variety of valves and fittings from The SWAGELOK Companies. A small selection is shown here. For a complete selection, refer to our Master Product Binder or contact your local Authorized Sales & Service Representative.

CAJON VCR® Metal Gasket Face Seal Fittings



CAJON VCO® O-Ring Face Seal Fittings



NUPRO Packless Valves

WHITEY Bell Valves



CAJON Automatic Tube Weld Fittings



CAJON MICRO-FIT™ Mini-weld Fittings



1-800-265-7575 336-3453
800 CONFEDERATION ST.
P.O. BOX 386 SARNIA, ONT. N7T 7J2

Past-Presidents of the Sarnia Section of I.S.A.

1946/47	Bill Graeb	1971/72	Curt McDonald
1947/48	Amby Upfold	1972/73	Everett Maness
1948/49	Ron Chamberlane	1973/74	Stan Thrift
1949/50	Don Livingstone	1974/75	E. A. Comello
1950/51	Amby Upfold	1975/76	Bernard West
1951/52	Ken Goldring	1976/77	Jim Henrikson
1952/53	Amby Upfold	1977/78	Jim Johnson
1953/54	Warren McKay	1978/79	Ron Thurier
1954/55	Jack Heatley	1979/80	Dave Braedley
1955/56	Larry Hall	1980/81	John Stassen
1956/57	Harold Kohlmeier	1981/82	Wayne Jamieson
1957/58	Ron Asselstine	1982/83	Frank Bandura
1958/59	Mike Hicks	1983/84	John Tranter
1959/60	Mike Hicks	1984/85	Robb Sharp
1960/61	Mike Hicks	1985/86	Ron Kells
1961/62	George Mills	1986/87	Howie Whitton
1962/63	Robert Brayne	1987/88	Joe Lobo
1963/64	Robert Newman	1988/89	Irvin Hawkes
1964/65	Robert Newman	1989/90	Rich Patterson
1965/66	Ted Stock	1990/91	Ken Blair
1966/67	Ted Stock	1991/92	Jim Lomax
1967/68	Bill Rion	1992/93	Bob Kelly
1968/69	Bud Dodds	1993/94	Bill Arundell
1969/70	Ray Wechselberger	1994/95	Larry Corbett
1970/71	Bill Glendon	1995/96	Mike Murray

LAKESIDE

FISHER

FISHER CONTROLS INTERNATIONAL, INC.

Control valves - Globe and rotary

Noise and cavitation reduction control valves

Actuators and positioners - pneumatic, electric electro-hydraulic

REGULATORS - Steam, gas and liquids - tank blanketing

Process Instrumentation:

- Electronic and pneumatic controllers
- FIELDVUE™ - digital valve controllers

- FISHER SERVICE**
- Valve repairs, factory and site
 - Maintenance and shut-down management
 - Diagnostics for pneumatically operated valves
 - Start-up assistance
 - Asset Management Service

- CON-TEK**
- Steam Conditioning Valves and Desuperheaters

- H.D. BAUMANN**
- Control Valves and Control Equipment
 - General purpose control valves
 - Corrosion resistant valves
 - Low flow control valves

FISHER-ROSEMOUNT

FISHER-ROSEMOUNT SYSTEMS INC.

PROVOX distributed control systems and Rosemount System 3™

- Service:**
- Engineering and project management
 - Installation and start-up assistance
 - System life management

- DeltaV**
- Scalable process system for small process control applications



GO
SWITCH

GENERAL EQUIPMENT & MANUFACTURING COMPANY INC.

- Proximity limit switches

ISO 9001



Registered 1994

Lakeside Process Controls Ltd.

581 Vidal Street South, Sarnia, Ontario, N7T 2V8

Phone: (519) 332-2300 Fax: (519) 332-6640

"Superior Service Supporting You"